



User's Manual

Large Format Display

MultiSync® ME982

MultiSync® ME862

MultiSync® ME752

MultiSync® ME652

MultiSync® ME552

MultiSync® ME502

MultiSync® ME432

MODEL:

PN-ME982, PN-ME862, PN-ME752, PN-ME652, PN-ME552, PN-ME502, PN-ME432

Please find your model name on the label on the rear side of the monitor.

HDMI™

Table of Contents

DEAR CUSTOMER	2	External Control	45
Important Information	3	Controlling the Monitor via RS-232C	45
Safety Precautions and Maintenance	5	Controlling the Monitor via LAN	46
Recommended Use & Maintenance	11	Commands	50
Trademark and Software License	12	Proof of Play	50
Supplied Components	13	Troubleshooting	51
Part Names	14	Screen Image and Video Signal Issues.....	51
Connecting Peripheral Equipment	16	Hardware Issues.....	52
Connecting the Supplied Power Cord	18	Specifications	54
Mounting (for Customer)	18	Compatible signal list.....	54
Preparing the Remote Control	19	Product Specifications	55
Turning Power On/Off	20	Appendix-A External Resources	57
Power ON and OFF	20	Appendix-B Common Settings Menu List	59
Using Power Management	22	Picture.....	59
Basic Operation	23	Audio.....	61
Menu Screen	26	Appendix-C Administrator Settings Menu List	62
About the home screen.....	26	Input & Output.....	62
Application - File Explorer	28	Schedule.....	64
Application - Web Browser	30	Network.....	64
Application - Updater	31	Protect	67
Application - MediaPlayer	32	Setup	68
Application - Wireless Display (EShare)	37	Application	69
Advanced Operation	38	System.....	70
Creating a Power and Reboot Schedule	38	About	71
Setting Security and Locking the Monitor Controls.....	39	Mounting Precautions	
Setting the Remote Control ID Function	43	(For SHARP dealers and service engineers)	72
Connecting Multiple Monitors	44	Mounting (for Trained Installers).....	72
		Manufacturer's Recycling and Energy Information	77
		Energy Saving	77
		Addition explanation to EcoDesign Regulation.....	77

DEAR CUSTOMER

Thank you for your purchase of a product. To ensure safety and many years of trouble-free operation of your product, please read the “[Important Information](#)” carefully before using this product.

Mounting the monitor requires expertise and the work must be carefully performed by a trained service person in accordance with the section “[Mounting Precautions \(For SHARP dealers and service engineers\)](#)”.

NOTE:

- Product warranty does not cover damage caused by improper installation. Failure to follow these recommendations could result in voiding the warranty.

Important Information

To maintain compliance with EMC regulations, use shielded cables to connect to the following terminals: USB port, USB Type C port and Audio output terminal. Use shielded cables with ferrite core to connect to the following terminals: HDMI input terminal, RS-232C input terminal.

Supplier's Declaration of Conformity

SHARP LCD MONITOR, PN-ME982/PN-ME862/PN-ME752/PN-ME652/PN-ME552/PN-ME502/PN-ME432

This device complies with Part 15 of the FCC Rules. Operation is subject to the following two conditions: (1) This device may not cause harmful interference, and (2) this device must accept any interference received, including interference that may cause undesired operation.

Responsible Party:

SHARP ELECTRONICS CORPORATION
100 Paragon Drive, Montvale, NJ 07645
TEL: (630) 467-3000 www.sharppusa.com

U.S.A. ONLY

WARNING:

FCC Regulations state that any unauthorized changes or modifications to this equipment not expressly approved by the manufacturer could void the user's authority to operate this equipment.

NOTE:

This equipment has been tested and found to comply with the limits for a Class B digital device, pursuant to Part 15 of the FCC Rules. These limits are designed to provide reasonable protection against harmful interference in a residential installation.

This equipment generates, uses and can radiate radio frequency energy and, if not installed and used in accordance with the instructions, may cause harmful interference to radio communications. However, there is no guarantee that interference will not occur in a particular installation.

If this equipment does cause harmful interference to radio or television reception, which can be determined by turning the equipment off and on, the user is encouraged to try to correct the interference by one or more of the following measures:

- Reorient or relocate the receiving antenna.
- Increase the separation between the equipment and receiver.
- Connect the equipment into an outlet on a circuit different from that to which the receiver is connected.
- Consult the dealer or an experienced radio/TV technician for help.

U.S.A. ONLY

WARNING:

An apparatus with CLASS I construction shall be connected to a MAIN socket outlet with a protective earthing connection.

This product is designed for commercial application only and as such it falls outside the scope of Regulation (EU) 2023/826 laying down ecodesign requirements for off mode, standby mode, and networked standby energy consumption. Sharp do not recommend the product for domestic application and will not accept any liability for such use.

(For Customers in U.K.)

IMPORTANT

- The wires in this mains lead are coloured in accordance with the following code:

GREEN-AND-YELLOW:	"Earth"
BLUE:	"Neutral"
BROWN:	"Live"

- As the colours of the wires in the mains lead of this apparatus may not correspond with the coloured markings identifying the terminals in your plug proceed as follows:
 - The wire which is coloured GREEN-AND-YELLOW must be connected to the terminal in the plug which is marked by the letter **E** or by the safety earth symbol \perp or coloured green or green-and-yellow.
 - The wire which is coloured BLUE must be connected to the terminal which is marked with the letter **N** or coloured black.
 - The wire which is coloured BROWN must be connected to the terminal which is marked with the letter **L** or coloured red.
- Ensure that your equipment is connected correctly. If you are in any doubt consult a qualified electrician.

"WARNING: THIS APPARATUS MUST BE EARTHED."



Information on the Disposal of this Equipment and its Batteries

IF YOU WISH TO DISPOSE OF THIS EQUIPMENT OR ITS BATTERIES, DO NOT USE THE ORDINARY WASTE BIN, AND DO NOT PUT THEM INTO A FIREPLACE!

Used electrical and electronic equipment and batteries should always be collected and treated SEPARATELY in accordance with local law.

Separate collection promotes an environment-friendly treatment, recycling of materials, and minimizing final disposal of waste. IMPROPER DISPOSAL can be harmful to human health and the environment due to certain substances! Take USED EQUIPMENT to a local, usually municipal, collection facility, where available.

Remove USED BATTERIES from equipment, and take them to a battery collection facility; usually a place where new batteries are sold.

If in doubt about disposal, contact your local authorities or dealer and ask for the correct method of disposal.

ONLY FOR USERS IN THE EUROPEAN UNION, AND SOME OTHER COUNTRIES; FOR INSTANCE NORWAY AND SWITZERLAND: Your participation in separate collection is requested by law.

The symbol shown above appears on electrical and electronic equipment and batteries (or the packaging) to remind users of this. If 'Hg' or 'Pb' appears below the symbol, this means that the battery contains traces of mercury (Hg) or lead (Pb), respectively.

Users from PRIVATE HOUSEHOLDS are requested to use existing return facilities for used equipment and batteries.

Batteries are collected at points of sale. Return is free of charge.

If the equipment has been used for BUSINESS PURPOSES, please contact your SHARP dealer who will inform you about take-back. You might be charged for the costs arising from take-back. Small equipment (and small quantities) might be taken back by your local collection facility. For Spain: Please contact the established collection system or your local authority for take-back of your used products.

Securing personal information: Personally identifiable information, such as IP addresses, may be saved on the monitor. Before transferring or disposing of the monitor, clear this data by performing the FACTORY RESET function.



- NOTE:**
- (1) The contents of this manual may not be reprinted in part or whole without permission.
 - (2) The contents of this manual are subject to change without notice.
 - (3) Great care has been taken in the preparation of this manual; however, should you notice any questionable points, errors or omissions, please contact us.
 - (4) The image shown in this manual is indicative only. If there is inconsistency between the image and the actual product, the actual product shall govern.
 - (5) Notwithstanding articles (3) and (4), we will not be responsible for any claims on loss of profit or other matters deemed to result from using this device.
 - (6) This manual is commonly provided to all regions so they may contain descriptions that are pertinent for other countries.

Safety Precautions and Maintenance



FOR OPTIMUM PERFORMANCE, PLEASE NOTE
THE FOLLOWING WHEN SETTING UP AND
USING THE LCD COLOR MONITOR:





About the Symbols

To ensure safe and proper use of the product, this manual uses a number of symbols to prevent injury to you and others as well as damage to property. The symbols and their meanings are described below. Be sure to understand them thoroughly before reading this manual.

 WARNING	Failing to heed this symbol and handling the product incorrectly could result in accidents leading to major injury or death.
 CAUTION	Failing to heed this symbol and handling the product incorrectly could result in personal injury or damage to surrounding property.

Examples of symbols







	This symbol indicates a warning or caution.
	This symbol indicates a prohibited action.
	This symbol indicates a mandatory action.

 WARNING	
 UNPLUG THE POWER CORD	<p>Unplug the power cord if the product malfunctions.</p> <p>Should the product emit smoke or strange odors or sounds, or if the product has been dropped or the cabinet broken, turn off the product's power, then unplug the power cord from the power outlet. Contact your dealer for repairs.</p> <p>Never try to repair the product on your own. Doing so is dangerous.</p>
 DO NOT MODIFY	<p>Do not open or remove the product's cabinet.</p> <p>Do not disassemble the product.</p> <p>There are high voltage areas in the product. Opening or removing product covers and modifying the product may expose you to electric shock, fire, or other risks.</p> <p>Refer all servicing to qualified service personnel.</p>
 PROHIBITED	<p>Do not use the product if it has structural damage.</p> <p>If you notice any structural damage such as cracks or unnatural wobbling, please refer servicing to qualified service personnel. If the product is used in this condition, the product may fall or cause personal injury.</p>



WARNING

Handling the power cord.

 PROHIBITED	<p>Do not scratch or modify the cord.</p> <ul style="list-style-type: none">• Do not place heavy objects on the cord.• Do not let the weight of the product rest on the cord.• Do not cover the cord with a rug, etc.• Do not bend, twist or pull the cord with excessive force.• Do not apply heat to the cord. <p>Handle the power cord with care. Damaging the cord could lead to fire or electric shock. If the cord gets damaged (exposed core wires, broken wires, etc.), turn off the product's power, then unplug the power cord from the power outlet. Ask your dealer to replace it.</p>
 DO NOT TOUCH	<p>Do not touch the power plug if you hear thunder. Doing so could result in electric shock.</p>
 DO NOT TOUCH WITH WET HANDS	<p>Do not connect or disconnect the power cord with wet hands. It may cause an electric shock.</p>
 REQUIRED	<p>Please use the power cord provided with this product. Do not exceed the product's specified power supply voltage where it is installed. Doing so could result in a fire or electric shock. Please refer to the power supply voltage information in the specification.</p> <p>If a power cord is not supplied with this product, please contact us. For all other cases, please use the power cord with the plug style that matches the power socket where the product is located. The compatible power cord corresponds to the AC voltage of the power outlet and has been approved by, and complies with, the safety standards in the country of purchase.</p>
 MUST BE EARTHED	<p>This equipment is designed to be used in the condition of the power cord connected to the earth. If the power cord is not connected to the earth, it may cause electric shock. Please make sure the power cord is connected to the wall outlet directly and earthed properly. Do not use a 2-pin plug converter adapter.</p>
 REQUIRED	<p>For proper installation it is strongly recommended to use a trained service person. Failure to follow the standard installation procedures could result in damage to the product or injury to the user or installer.</p>
 REQUIRED	<p>Please install the product in accordance with the following information. This product cannot be used or installed without the table top stand or other mounting accessory for support.</p> <p>When transporting, moving, or installing the product, please use as many people as necessary (ME982/ME862/ME752: at least 4, ME652/ME552/ME502/ME432: at least 2) to be able to lift the product by the two handles without causing personal injury or damage to the product.</p> <ul style="list-style-type: none">• ME982/ME862/ME752: In order to install the monitor on ceiling or wall, use a lifting device attached to the eyebolts. Do not lift the product only by people. The product may fall causing personal injury.• ME982/ME652: DO NOT use this product on the floor with the table top stand. Please use this product on a table or with a mounting accessory for support. <p>Please refer to the instructions included with the optional mounting equipment for detailed information about attaching or removing.</p> <p>Do not cover the vent on the product. Improper installation of the product may result in damage to the product, an electric shock or fire.</p>



WARNING



REQUIRED

Do not install the product in the locations below:

- Poorly ventilated spaces.
- Near a radiator, other heat sources, or in direct sunshine.
- Continual vibration areas.
- Humid, dusty, steamy, or oily areas.
- An environment where there are corrosive gases (sulfur dioxide, hydrogen sulfide, nitrogen dioxide, chlorine, ammonia, ozone, etc.).
- Outdoors.
- High-temperature environment where humidity changes rapidly and condensation is likely to occur.
- A ceiling or wall that is not strong enough to support the product and mounting accessories.

Do not mount the product upside down.



REQUIRED

Prevent tipping and falling for earthquakes or other shocks.

To prevent personal injury or damage to the product caused by tipping over due to earthquakes or other shocks, make sure to install the product in a stable location and take measures to prevent falling.

The measures to prevent falling and tipping are intended for reducing the risk of injury, but may not guarantee the effectiveness against all earthquakes.

The product may tip causing personal injury.

- When using the product with the optional table top stand, fasten the product to a wall using a cord or chain that can support the weight of the product in order to prevent the product from falling.
- Depending on the table top stand, the stand has the structure for preventing tipping.
- Please refer to the table top stand manual.
- Be sure to remove the cord or chain from the wall before moving the product to prevent personal injury or damage to the product.

ME982/ME862/ME752/ME652

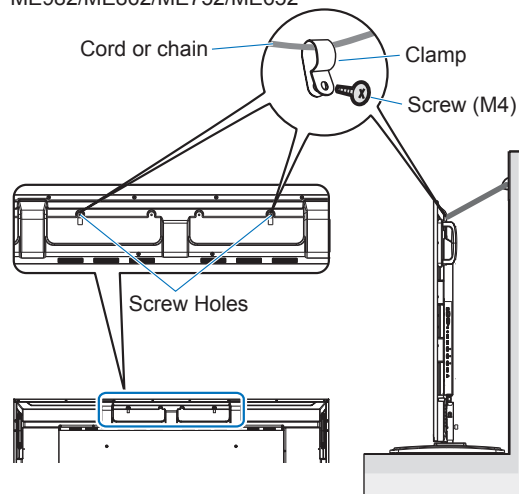







The product may fall causing personal injury.

- Do not attempt to hang the product using an installation safety wire.
- Please install the product in an area on the wall or ceiling strong enough to support the weight of the product.
- Prepare the product using mounting accessories, such as hook, eyebolt, or mounting parts, and then secure the product with a safety wire. The safety wire must not be tight.
- Please make sure the mounting accessories are strong enough to support the product weight and size before installing it.



WARNING

 REQUIRED	<p>Stability Hazard. The product may fall, causing serious personal injury or death. To prevent injury, this product must be securely attached to the floor/wall in accordance with the installation instructions. Many injuries, particularly to children, can be avoided by taking simple precautions such as:</p> <ul style="list-style-type: none">• ALWAYS use stands or installation methods recommended by the manufacturer of the product set.• ALWAYS use furniture that can safely support the product.• ALWAYS ensure the product is not overhanging the edge of the supporting furniture.• ALWAYS educate children about the dangers of climbing on furniture to reach the product or its controls.• ALWAYS route cords and cables connected to your product so they cannot be tripped over, pulled or grabbed.• NEVER place a product in an unstable location.• NEVER place the product on tall furniture (for example, cupboards or bookcases) without anchoring both the furniture and the product to a suitable support.• NEVER place the product on cloth or other materials that may be located between the product and supporting furniture.• NEVER place items that might tempt children to climb, such as toys and remote controls, on the top of the product or furniture on which the product is placed. <p>If the existing product is going to be retained and relocated, the same considerations as above should be applied.</p>
 PROHIBITED	<p>Do not place this product on a sloping or unstable cart, stand or table. Doing so could lead to falling or tipping and cause personal injury.</p>
 PROHIBITED	<p>Do not insert objects of any kind into the cabinet slots. It may cause electric shock, fire, or product failure. Keep objects away from children and babies. If objects get into the cabinet slot, turn off the product's power, then unplug the power cord from the power outlet. Contact your dealer for repairs.</p>
 DO NOT WET	<p>Do not spill any liquids into the cabinet or use your product near water. Immediately turn off the power and unplug your product from the wall outlet, then refer servicing to qualified service personnel. It may cause an electric shock or start a fire. Do not install the product under equipment that discharges water, such as air conditioners.</p>
 PROHIBITED	<p>Do not use flammable gas sprays to remove dust when cleaning the product. Doing so could lead to a fire.</p>
 PROHIBITED	<p>Usage of the product must not be accompanied by fatal risks or dangers that, could lead directly to death, personal injury, severe physical damage or other loss, including nuclear reaction control in nuclear facility, medical life support system, and missile launch control in a weapon system.</p>









CAUTION

Handling the power cord.

 REQUIRED	The monitor should be installed close to an easily accessible power outlet.
 REQUIRED	When connecting the power cord to the product's AC input terminal, make sure the connector is fully and firmly inserted. An incomplete connection of the power cord may cause overheating of the plug; it allows dust to get on the plug connection, which can lead to a fire. Touching the pins of a partially inserted plug may lead to an electric shock. If a clamp and a screw are provided with the product, fasten the power cord to the product by attaching them to prevent a loose connection.
 REQUIRED	Handling the power cord by following below to avoid fire or electric shock. <ul style="list-style-type: none">• When connecting or disconnecting the power cord, pull the power cord out by holding onto its plug.• Unplug the power cord from the power outlet before cleaning the product or when not planning to use the product for an extended time.• When the power cord or plug is heat or damaged, unplug the power cord from the power outlet, and contact a qualified service person.
 REQUIRED	Regularly dust off the power cord by using a soft dry cloth.
 REQUIRED	Before moving the product, make sure the product power is off, then unplug the power cord from the power outlet and check that all cables connecting the product to other devices are disconnected.
 PROHIBITED	Do not use the power cord with a power tap. Adding an extension cord may lead to fire as a result of overheating.
 PROHIBITED	Do not bind the power cord and the USB cable. It may trap heat and cause a fire.
 PROHIBITED	Do not connect to a LAN with excessive voltage. When using a LAN cable, do not connect to a peripheral device with wiring that might have excessive voltage. Excessive voltage on the LAN port may cause an electric shock.
 PROHIBITED	Do not climb on the table where the product is installed. Do not install the product on a wheeled table if the wheels on the table have not been properly locked. The product may fall, causing damage to the product or personal injury.
 REQUIRED	Installation, removal, and height adjustment of the optional table top stand. <ul style="list-style-type: none">• When installing the table top stand, handle the unit with care to avoid pinching your fingers.• Installing the product at the wrong height can cause tipping. Please install your product at proper height to prevent personal injury or damage to the product.
 PROHIBITED	Do not push or climb on the product. Do not grab or hang onto the product. Do not rub or tap the product with hard objects. The product may fall, causing damage to the product or personal injury.
 PROHIBITED	Do not hit or strike the screen. Do not push against the screen with a pointed object. It can cause serious damage to the product or personal injury.



CAUTION

 REQUIRED	<p>Incorrect usage of batteries can result in leaks or bursting.</p> <ul style="list-style-type: none"> • Use the specified batteries only. • Insert batteries matching the (+) and (-) signs on each battery to the (+) and (-) signs of the battery compartment. • Do not mix battery brands. • Do not combine new and old batteries. This can shorten battery life or cause liquid leakage of batteries. • Remove dead batteries immediately to prevent battery acid from leaking into the battery compartment. <p>If leaked battery fluid gets on your skin or clothing, rinse immediately and thoroughly. If it gets into your eye, bathe your eye well rather than rubbing and seek medical treatment immediately. Leaked battery fluid that gets into your eye or your clothing may cause a skin irritation or damage your eye.</p> <ul style="list-style-type: none"> • If you will not use the remote control for a long time, remove the batteries. • Leaving a battery in an extremely high temperature surrounding environment, or a battery subject to extremely low air pressure, that can result in an explosion or the leakage of flammable liquid or gas. • Properly dispose of depleted batteries. Disposal of a battery into water, fire, or a hot oven, or mechanically crushing, cutting, or modifying a battery can result in an explosion. • Do not short-circuit the batteries. • Do not charge the batteries. The batteries provided are not rechargeable. • Contact your dealer or local authorities when disposing of batteries.
 PROHIBITED	<p>Do not stay in contact with the parts of the product that become hot for long periods of time. Doing so may result in low-temperature burns.</p>
 REQUIRED	<p>Suitable for entertainment purposes at controlled luminous environments, to avoid disturbing reflections from the screen.</p>
 REQUIRED	<p>We recommend wiping clean the ventilation holes a minimum of once a month. Failure to do so could lead to fire or electric shock or damage to the product.</p>
 REQUIRED	<p>To ensure the product's reliability, please clean the ventilation holes at the rear side of the cabinet at least once a year to remove dirt and dust. Failure to do so could lead to fire or electric shock or damage to the product.</p>
 REQUIRED	<p>Avoid locations with extreme temperatures and humidity. Failure to do so could lead to fire or electric shock or damage to the product. The usage environment for this product is as follows:</p> <ul style="list-style-type: none"> • The operating temperature: 0 °C to 40 °C/32 °F to 104 °F/ humidity: 20 to 80% (without condensation) • The storage temperature: -20 °C to 60 °C/-4 °F to 140 °F/ humidity: 10 to 90% (without condensation)

- NOTE:**
- This product can only be serviced in the country where it was purchased.
 - Continuous operating time and warranty.
This product is designed for a maximum daily use of 18 hours. Continual use in excess of 18 hours per day is not covered by the warranty.
 - When you use a network, your communication data is exposed to the risks of being stolen or illegally accessed. To avoid these risks, you need to use this monitor in a secure network environment.

Recommended Use & Maintenance

■ Recommended Use

Ergonomics

To realize the maximum ergonomic benefits, we recommend the following:

- For optimum performance of the monitor, allow 20 minutes for warming up. Avoid reproduction of still patterns on the monitor for long periods of time to avoid image persistence (after image effects).
- Rest your eyes periodically by focusing on an object at least 5 feet away. Blink often.
- Position the monitor at a 90° angle to windows and other light sources to minimize glare and reflections.
- Adjust the monitor's brightness, contrast and sharpness controls to enhance readability.
- Get regular eye checkups.
- Use the preset Size and Position controls with standard input signals.
- Use the preset color settings.
- Use non-interlaced signals.
- Do not view the primary color blue on a dark background. It is difficult to see and may cause eye fatigue due to insufficient contrast.
- Restarting the Android system.
To maintain stable operation of APPLICATION mode, the Android system must be restarted once a day.
If [Power Save] is enable, turn off the power.
If [Power Save] is disable, turn off the main power.
Android system can be restarted at the specified time (See [page 64](#)).

■ Maintenance

Cleaning the LCD Screen

- When the LCD screen is dusty, please gently wipe with a soft cloth.
- Clean the LCD screen surface with a lint-free, non-abrasive cloth. Avoid using any cleaning solution or glass cleaner!
- Please do not rub the LCD screen with a hard or abrasive material.
- Please do not apply pressure to the LCD screen surface.
- Please do not use OA cleaner as it will cause deterioration or discoloration on the LCD screen surface.

Cleaning the Cabinet

- Unplug the power supply.
- Gently wipe the cabinet with a soft cloth.
- To clean the cabinet, dampen the cloth with a neutral detergent and water, wipe the cabinet and follow with a dry cloth.

NOTE: • DO NOT clean with benzene thinner, alkaline detergent, alcoholic system detergent, glass cleaner, wax, polish cleaner, soap powder, or insecticide. Rubber or vinyl should not be in contact with the cabinet for an extended period of time.

These types of fluids and materials can cause the paint to deteriorate, crack or peel.

Trademark and Software License

■ Trademarks

DisplayPort™ and the DisplayPort™ logo are trademarks owned by the Video Electronics Standards Association (VESA®) in the United States and other countries.

Microsoft® and Windows® are trademarks of the Microsoft group of companies.

The terms HDMI, HDMI High-Definition Multimedia Interface, HDMI Trade dress and the HDMI Logos are trademarks or registered trademarks of HDMI Licensing Administrator, Inc.

Blu-ray is a trademark of Blu-ray Disc Association.

MacOS is a trademark of Apple Inc., registered in the U.S. and other countries.

Android is a trademark or registered trademarks of Google LLC.

Ethernet is a registered trademark of Xerox Corporation.

VESA is either registered trademark or trademark of Video Electronics Standards Association in the United States and/or other countries.

USB Type-C® and USB-C® are registered trademarks of USB Implementers Forum.

All other brands and product names are trademarks or registered trademarks of their respective owners.

Crestron™, the Crestron logo, Crestron Connected™, Crestron Fusion™, and Xio Cloud™ are either trademarks or registered trademarks of Crestron Electronics, Inc. in the United States and/or other countries.

PJLink trademark and logo are trademarks applied for registration or are already registered in Japan, the United States of America and other countries and areas.

[Notice] About the MPEG-4 AVC, MPEG-4 Visual license included in this product

1. MPEG AVC

THIS PRODUCT IS LICENSED UNDER THE AVC PATENT PORTFOLIO LICENSE FOR THE PERSONAL USE OF A CONSUMER OR OTHER USES IN WHICH IT DOES NOT RECEIVE REMUNERATION TO (i) ENCODE VIDEO IN COMPLIANCE WITH THE AVC STANDARD ("AVC VIDEO") AND/OR (ii) DECODE AVC VIDEO THAT WAS ENCODED BY A CONSUMER ENGAGED IN A PERSONAL ACTIVITY AND/OR WAS OBTAINED FROM A VIDEO PROVIDER LICENSED TO PROVIDE AVC VIDEO. NO LICENSE IS GRANTED OR SHALL BE IMPLIED FOR ANY OTHER USE. ADDITIONAL INFORMATION MAY BE OBTAINED FROM MPEG LA, L.L.C. SEE [HTTP://WWW.MPEGLA.COM](http://www.mpegla.com)

2. MPEG-4 Visual

THIS PRODUCT IS LICENSED UNDER THE MPEG-4 VISUAL PATENT PORTFOLIO LICENSE FOR THE PERSONAL AND NON-COMMERCIAL USE OF A CONSUMER FOR (i) ENCODING VIDEO IN COMPLIANCE WITH THE MPEG-4 VISUAL STANDARD ("MPEG-4 VIDEO") AND/OR (ii) DECODING MPEG-4 VIDEO THAT WAS ENCODED BY A CONSUMER ENGAGED IN A PERSONAL AND NONCOMMERCIAL ACTIVITY AND/OR WAS OBTAINED FROM A VIDEO PROVIDER LICENSED BY MPEG LA TO PROVIDE MPEG-4 VIDEO. NO LICENSE IS GRANTED OR SHALL BE IMPLIED FOR ANY OTHER USE. ADDITIONAL INFORMATION INCLUDING THAT RELATING TO PROMOTIONAL, INTERNAL AND COMMERCIAL USES AND LICENSING MAY BE OBTAINED FROM MPEG LA, LLC. SEE [HTTP://WWW.MPEGLA.COM](http://www.mpegla.com)

Supplied Components

If any component should be missing, please contact your dealer.

- Liquid Crystal Display Monitor: 1
- Remote control unit: 1
- Remote control unit battery: 2
- Power cord
- HDMI cable: 1
- Clamp: 1
- Screw: 1
- Setup Manual: 1
- Important Information: 1

* For environmental protection!

Do not dispose of batteries in household waste. Follow the disposal instructions for your area.

Depending on the country where the LCD monitor is shipped to, AAA batteries are not included in the box contents.

Part Names

■Front View

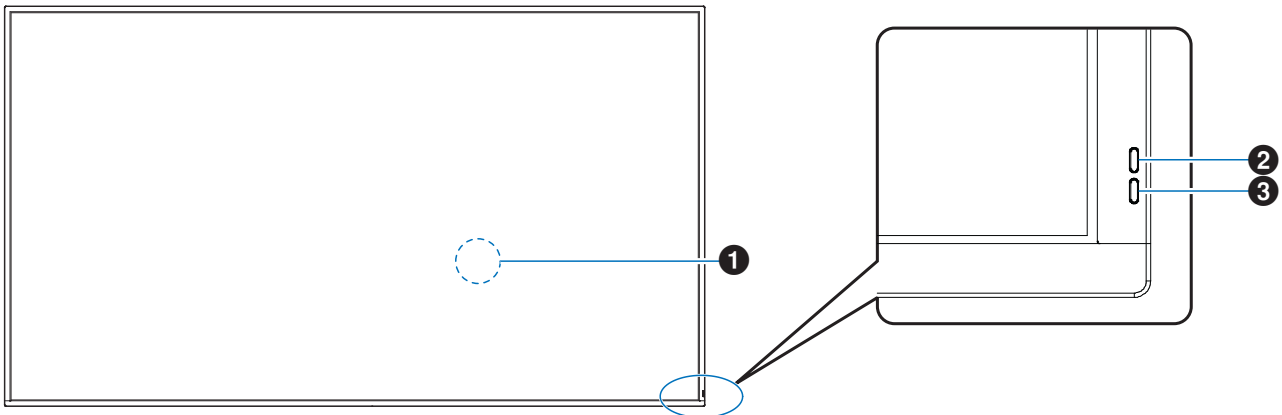

- ❶ Remote Control Sensor (See [page 19](#))
- ❷ Ambient light sensor (See [page 60](#))
- ❸ Power Indicator (See [page 20](#))

TIP: • Ambient light sensor detects the level of ambient light, allowing the monitor to make automatic adjustments to the backlight setting, resulting in a more comfortable viewing experience. Do not cover this sensor.

■Rear View

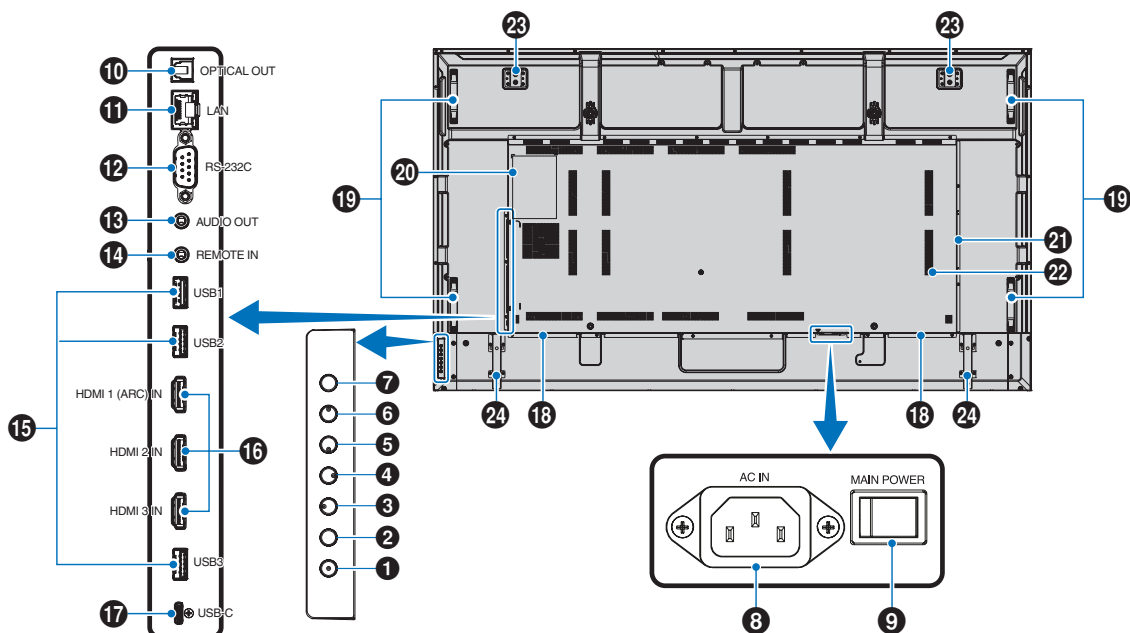

- ❶ Power Button (See [page 20](#))
- ❷ MENU/EXIT Button (See [page 15](#))
- ❸ RIGHT Button*¹ (See [page 15](#))
- ❹ LEFT Button*¹ (See [page 15](#))
- ❺ DOWN Button*¹ (See [page 15](#))
- ❻ UP Button*¹ (See [page 15](#))
- ❼ INPUT/SET Button (See [page 15](#))
- ❽ AC input terminal (See [page 18](#))
- ❾ Main Power Switch (See [page 20](#))
- ❿ Digital audio output (optical) terminal (See [page 16](#))

- 11 LAN terminal (See [page 16](#))
- 12 RS-232C input terminal (See [page 16](#))
- 13 AUDIO output terminal (See [page 16](#))
- 14 REMOTE input terminal (See [page 16](#))
- 15 USB ports (See [page 16](#))
- 16 HDMI 1/2/3 input terminal (HDMI1 (ARC)/HDMI2/HDMI3) (See [page 17](#))
- 17 USB Type-C port (power supply 5 V/3 A) (See [page 17](#))
- 18 Internal Speaker

- 19 Handles (4: ME982, ME862, ME752 / 2: ME652, ME552, ME502, ME432)
- 20 Label
- 21 Optional wireless adapter slot*
* Please contact your supplier about the conditions.
- 22 Vents
- 23 Eyebolts (ME982, ME862, ME752)
- 24 Stand holders (ME982, ME862, ME752)

Button Functions

- 2 MENU/EXIT:
Opens the OSD menu when the OSD menu is closed.
Acts as a back button within the OSD menu to move to the previous OSD menu.
Acts as an exit button to close the OSD menu when on the main menu.
- 3 RIGHT*1:
Navigates to the right through the OSD Control menus.
Increases adjustments for individual OSD settings.
Directly adjusts the VOLUME when the OSD menu is closed with HDMI/USB-C input.
- 4 LEFT*1:
Navigates to the left through the OSD Control menus.
Decreases adjustments for individual OSD settings.
Directly adjusts the VOLUME when the OSD menu is closed with HDMI/USB-C input.

- 5 DOWN*1:
Navigates down through the OSD Control menus.
- 6 UP*1:
Navigates up through the OSD Control menus.
- 7 INPUT/SET:
INPUT: Opens the INPUT menu when the OSD menu is closed.
[HOME], [HDMI1], [HDMI2], [HDMI3], [USB-C].
Input names are shown as their factory preset name.
SET: Selects, or sets the setting for the highlighted function in the OSD menu.

*1: The RIGHT, LEFT, DOWN and UP functions change according to the monitor orientation (landscape/portrait).

TIP: • OSD is an abbreviation of On-Screen Display.

Remote Control



- 1 Signal transmitter
- 2 Operation buttons (See [page 23](#))

Connecting Peripheral Equipment

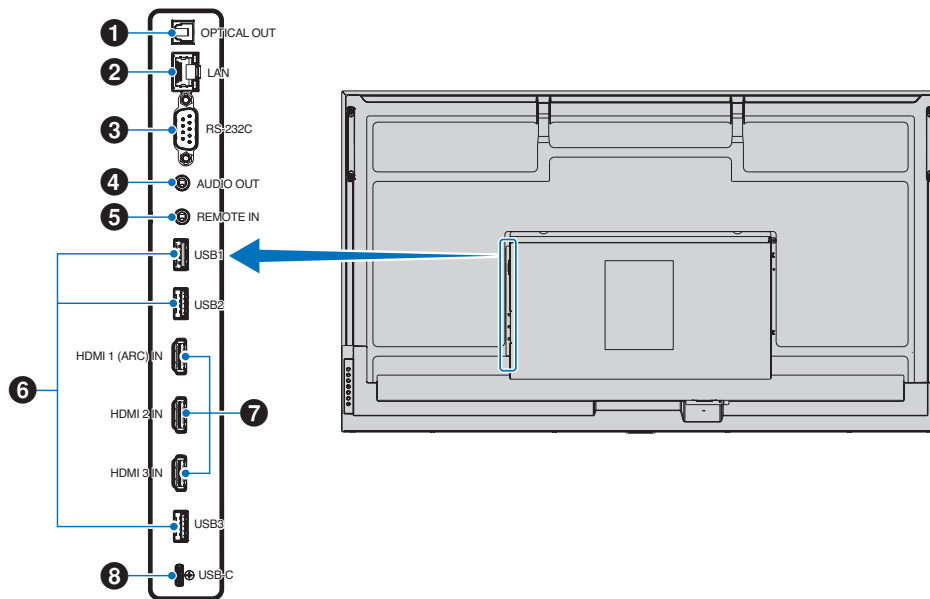

1 Digital audio output (optical) terminal

For connection to an audio device equipped with a digital audio input terminal.

2 LAN terminal (RJ-45)

Connect to LAN in order to manage and control the monitor over the network.

3 RS-232C input terminal (D-Sub 9-pin)

Connect RS-232C input from external equipment, such as a computer, in order to control RS-232C functions. See [page 45](#).

4 AUDIO output terminal

Audio signal output from USB-C and HDMI to an external device (stereo receiver, amplifier, etc.).

NOTE: • This connector is not a headphone terminal.

5 REMOTE input terminal

Use an optional sensor unit by connecting it to your monitor.

NOTE: • Do not use this connector unless specified.

TIP:

- When the optional sensor unit is connected, the monitor's remote control sensor is disabled.
- For the remote control, please use the remote control included with this monitor.

6 USB ports

USB1 (Hub/0.5 A): Downstream port (USB Type-A).

USB2 (Hub/0.9 A): Downstream port (USB Type-A).

Connection used by external USB devices (such as cameras, flash memory, keyboards, etc.).

USB flash drive reader for use with the internal Media Player.

USB3 (Hub/0.9 A): Downstream port (USB Type-A) for a device connected to the USB-C port.

A computer connected to the USB-C port can be controlled by the external devices via this port.

This connection can also be used by external USB devices (such as cameras, flash memory, keyboards, etc.).

NOTE:

- Please make sure the connector shape and orientation is correctly aligned when connecting the USB device or cable.
- Connecting/disconnecting a USB flash drive with the monitor already powered on is not recommended. To prevent damage to the monitor and possible corruption of the connected device's data files, the monitor's main power switch should be off before making connections or disconnections.

TIP:

- Format a USB flash drive in the FAT32 format. Refer to the computer's instruction user's manual or Help file on how to format a USB flash drive.
- If the monitor does not recognize a connected USB flash drive, make sure the file structure is FAT32.
- The monitor is not guaranteed to work with all USB storage devices sold commercially.
- Android system folders might be created automatically when a USB flash drive is connected to USB1/USB2/USB3.

7 HDMI 1/2/3 input terminal (HDMI1 (ARC)/HDMI2/HDMI3)

HDMI signals input.

Please use an HDMI cable with the HDMI logo.

When input signal is 4K, please use high-speed HDMI cable.

HDMI1(ARC):

Also supports ARC (Audio Return Channel) for audio output.

ARC sends the monitor's sound to audio equipment with an HDMI1 ARC connector.

- TIP:**
- Use the included ARC-supported HDMI cable. The audio equipment will output the monitor's audio. The audio equipment can be controlled with the included remote control.
 - Some HDMI cables and devices may not show an image correctly due to different HDMI specifications.
 - This monitor supports HDCP (High-bandwidth Digital Contents Protection) coding. HDCP is a system for preventing illegal copying of video data sent over a digital signal. If you are unable to view material via the digital inputs, this does not necessarily mean that the monitor is not functioning properly.
 - Compatible signal list is on the [page 54](#).

8 USB Type-C port (power supply 5 V/3 A)

Check the shape of the connectors when connecting a USB cable. When supplying power via the USB Type-C port, use a USB cable supporting 3 A.

You can connect a device that supports DisplayPort alternate mode. In order to supply power to connected devices, it is necessary to support the Power delivery standard.

NOTE:

- Do not tie the USB cable. Otherwise, it may cause overheating or fire.

TIP:

- The Power Delivery function is not guaranteed to work with all devices. Please check the connected device's user manual and specifications for its power capabilities and requirements.

To maintain compliance with EMC regulations, use shielded cables to connect to the following terminals: USB port, USB Type C port and Audio output terminal. Use shielded cables with ferrite core to connect to the following terminals: HDMI input terminal, RS-232C input terminal.

- TIP:**
- Do not connect or disconnect cables when turning on the monitor's main power or other external equipment's power as this may result in loss of image.
 - Do not use an attenuating (built-in resistor) audio cable. Using an audio cable with a built-in resistor will lower the sound level.

Before making connections:

- Turn off the device's power before connecting it to the monitor.
- Refer to the device's user manual for available connection types and instructions for the device.
- We recommend turning off the monitor's main power before connecting or disconnecting a USB flash drive to avoid data corruption.
- Check the USB flash drive for viruses as necessary.

Connecting the Supplied Power Cord

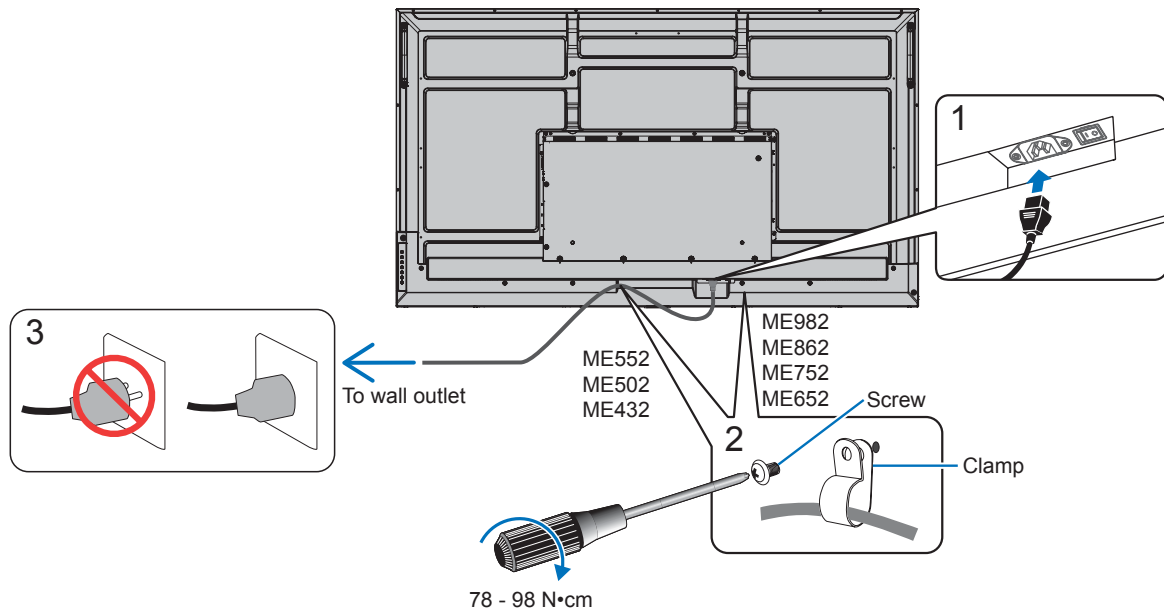

NOTE: • Please make sure that enough power is supplied to the monitor. Please refer to the “Power Supply” in the specification (See [“Product Specifications” on page 55](#)).

Mounting (for Customer)

Please contact your supplier as they may be able to provide a list of qualified installation professionals. Mounting on a wall or ceiling and hiring a technician is the customer’s responsibility.

Maintenance

- Periodically check for loose screws, gaps, distortions, or other problems that may occur with the mounting equipment. If a problem is detected, please refer to qualified personnel for service.
- Regularly check the mounting location for signs of damage or weakness that may occur over time.

NOTE: • If using a cover made of glass or acrylic to protect the panel surface of the main unit, the panel is sealed and the internal temperature rises.

- Reduce the monitor’s brightness to prevent the internal temperature from rising. If the monitor is connected to a computer, use the computer’s power management function to control the monitor’s automatic power off.

Preparing the Remote Control

■ Install the remote control batteries

The remote control is powered by two 1.5 V AAA batteries.

To install or replace batteries:

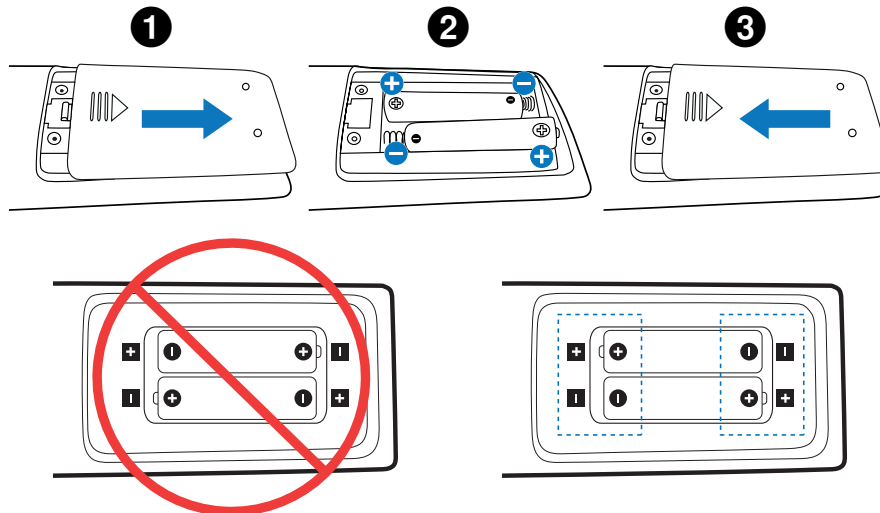

- NOTE:**
- If you do not intend to use the remote control for a long period of time, remove the batteries.
 - Use manganese or alkaline batteries only.

■ Operating Range for the Remote Control

Point the top of the remote control toward the monitor's remote control sensor during button operation.

Use the remote control within a distance of about 7 m (23 ft.) from the remote control sensor, or at a horizontal and vertical angle of within 30° and within a distance of about 3.5 m (10 ft.).

- TIP:**
- The remote control system may not function when direct sunlight or strong illumination strikes the remote control sensor, or when there is an object in the path.

Handling the remote control

- Do not expose to strong shock.
- Do not allow water or other liquid to splash on the remote control. If the remote control gets wet, wipe it dry immediately.
- Avoid exposure to heat and steam.
- Except to install the batteries, do not open the remote control.

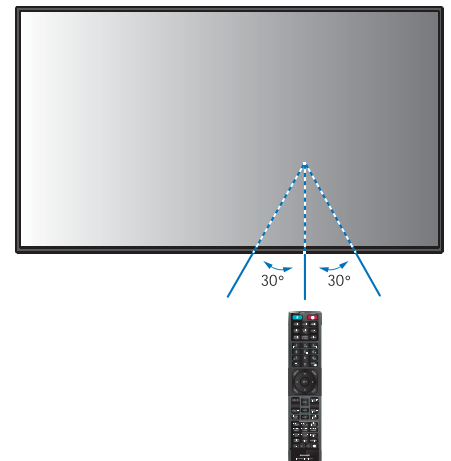

Turning Power On/Off

The Main Power switch must be in the ON position in order to power up the monitor using the POWER ON button on the remote control or the POWER button on the Control Panel.

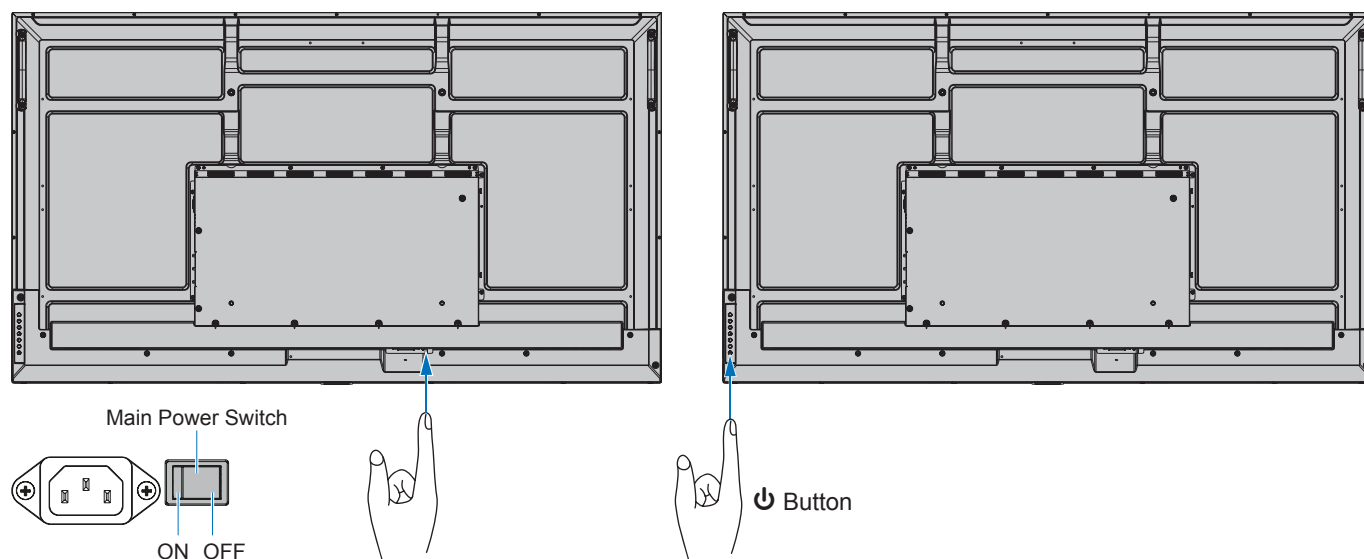

■ Operations after first power-on

When you turn on the power for the first time, the initial setting screen appears. Navigate the cursor to [Start] using the ▲/▼ buttons on the remote control and press the SET button to start. Configure the initial settings, such as setting the language, date and time, etc.

Power ON and OFF

Press the  button on the Control Panel or POWER ON button on the remote control to turn on the monitor.

Press the POWER button again on the monitor or press the STANDBY button on the remote control. The power is turned off. (Standby state)

The monitor's power LED indicates the current status of the monitor. Please refer to the following table for information about the power indicator.

Status of the monitor	Power LED lighting pattern	Condition	Recovery
Power on	Glowing blue		
Power off	Glowing red		1. Turn on the monitor using the remote control or the monitor button.

*1: The monitor shifts to the waiting mode without input signal under the conditions below:

- [Power Save] is enabled.
- The period of time you set at [Power Save Settings] has been passed.

*2: [Mode] in [Power Save Settings] is set to [Normal].

Status of the monitor		Power LED lighting pattern	Condition	Recovery
Input signal waiting mode*1	Sleep state (Backlight off)	Blinking green	Under any of the conditions below: <ul style="list-style-type: none"> [Auto Input Change] is set to a setting except for [None]. [USB Power] is set to [On]. Connecting a cable to the USB Type-C port and [USB Power] is set to [Auto]. [Quick Start] is enable. Under the [Lock Settings], [Key] or [Key & IR] is set to [Select] and [All Lock] or [Custom Lock] is set to [Mode]. [CEC] in [Input & Output] is enabled. 	<ol style="list-style-type: none"> Turn on the monitor using the remote control or the monitor button. Send an AV signal input to the monitor. Disconnect and reconnect a signal cable.
	Networked standby mode	Glowing amber	Occurs when the conditions of the green blinking status are not met. Under any of the conditions below: <ul style="list-style-type: none"> Connecting a LAN cable to the LAN terminal and [LAN] is set to [Control Terminal] under [Advanced] in [Setup]. Connecting a HDMI cable to HDMI terminals and the currently selected input is [HDMI1, 2, 3] without input signal, and [Normal] is set to [Mode] in [Power Save Settings]. 	<ol style="list-style-type: none"> Turn on the monitor using the remote control or the monitor button. Send an AV signal input to the monitor.*2 Disconnect and reconnect a signal cable.
	Standby mode	Blinking amber	Occurs when the conditions of the green blinking or amber glowing status are not met. Under any of the conditions below: <ul style="list-style-type: none"> [LAN] is set to [Control Terminal] under [Advanced] in [Setup] and elapses for 3 minutes or longer without a signal via LAN. [RS-232C] is set to [Control Terminal] under [Advanced] in [Setup]. 	<ol style="list-style-type: none"> Turn on the monitor using the remote control or the monitor button. Disconnect and reconnect a signal cable.

*1: The monitor shifts to the waiting mode without input signal under the conditions below:

- [Power Save] is enabled.
- The period of time you set at [Power Save Settings] has been passed.

*2: [Mode] in [Power Save Settings] is set to [Normal].

- TIP:**
- The blue power indicator that the monitor is powered on and functioning normally can be turned off in the monitor's OSD menu options. See [page 69](#).
 - The indicator glows amber when the [Schedule] function is enabled.
 - When the main power switch is turned off while in standby state, the monitor will be in standby mode with a blue blinking LED when turned on again.

- NOTE:**
- If the indicator is blinking red in a combination of long and short durations, a certain failure might have occurred. Please contact your supplier.

The backlight used for this monitor has a limited life and its brightness decreases with the usage time.

Do not display a still picture for a long period, as this could cause a residual image.

To avoid shortening this monitor's lifetime, please note the following:

- Turn off the monitor's main power switch when not in use.
- Use the  button on the main unit or the STANDBY button on the remote control to put the unit in standby state.
- Use [Power Save Settings] in the [Protect] OSD menu. When there is no input signal the monitor will automatically switch to power save mode.
- Use [Schedule] in the OSD menu to automatically control the monitor's on and standby power states as required. When using the schedule function, set [Date & Time] in the [System] OSD menu.

Using Power Management

This function decreases the power consumption of the monitor when it is not in use.

When connected to a computer, power consumption by the monitor reduces automatically if the keyboard or mouse are not used during the time set in the computer's power management settings. Refer to your computer's user manual for more information.

When connected to an AV source, such as a Blu-ray, DVD, or streaming video player, power consumption by the monitor reduces automatically after a certain amount of time has passed since the monitor recognized "no signal input". This option is turned on or off in the [Power Save] settings in [Power Save Settings] menu of the OSD. See [page 67](#).

- TIP:**
- Depending on the computer and display card used, this function may not operate.
 - After the video signal is lost, the monitor automatically turns off after a preset time period. Please refer to the [Time Setting] in [Power Save Settings] [page 67](#).
 - Schedules can be created for the monitor to power on or standby at specific times. See [page 38](#).
 - Please refer to the [Power Save] in [Power Save Settings] for the power management function.

Basic Operation

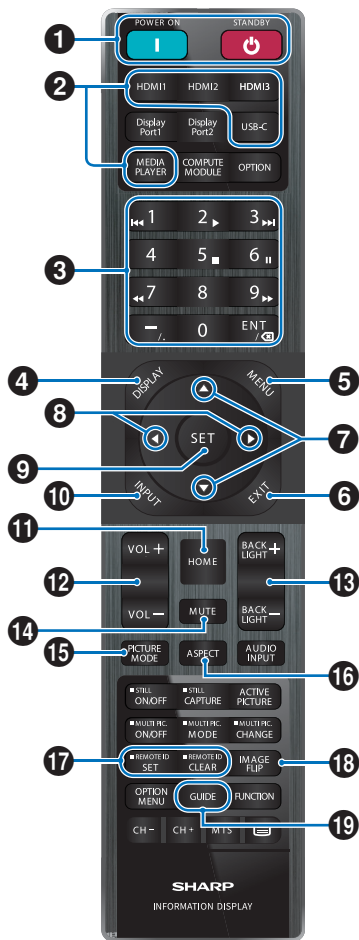

- TIP:**
- The buttons with no explanation are not used with your monitor model.
 - Some Remote Control buttons are used for CEC (Consumer Electronics Control). Please see [page 63](#).

1 POWER ON and STANDBY Buttons

POWER ON resumes full power from low power mode.
STANDBY puts the monitor in low power mode.
See [page 20](#).

2 DIRECT INPUT Buttons

Immediately changes the input to the one named on the button.
The button names reflect the factory preset name for the input.

3 KEYPAD

Press the buttons to set and change passwords, IP address, the channel, and set the REMOTE ID. See [page 43](#).

Some buttons are used for the CEC and the MediaPlayer function ("MediaPlayer" on [page 32](#)).

The - (hyphen) button is the same means as ". (dot)". The ENT button works as backspace.

4 DISPLAY Button

Shows/Hides the information OSD.

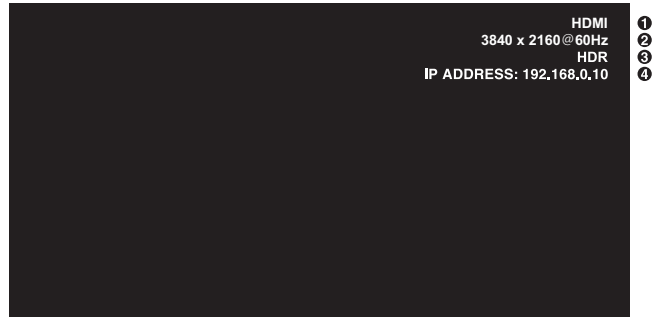

- 1 Input name
- 2 Input Signal Information
- 3 HDR Information
- 4 Communication Info*

* Shows when [Communication Information] is checked.
Green: Connected LAN.
Red: Not connected LAN.

Unlocks the remote control's buttons if they have been locked in the [Lock Settings] in the [Protect] menu.

Press and hold the DISPLAY button for more than five seconds to unlock the remote. See [page 41](#).

5 MENU Button

Opens and closes the OSD menu. See [page 26](#).

6 EXIT Button

Acts as a back button within the OSD to move to the previous OSD menu.

Acts as an EXIT button to close the OSD menu when on the main menu.

7 ▲/▼ Button (up/down button)

Acts as navigation buttons to move the highlighted area up or down.

8 ◀/▶ Button (left/right button)

Acts as navigation buttons to move the highlighted area left or right.

Increases or decreases the adjustment level within the selected OSD menu setting.

9 SET Button

When the OSD menu is open, this button acts as a set button when you make a selection.

10 INPUT Button

Opens and closes the INPUT menu.

The input names reflect the factory preset name for the input unless they are manually renamed in the OSD menu.

11 HOME Button

System main screen button.

12 VOLUME +/- Button

Increases or decreases the audio output level.

13 BACKLIGHT +/- Button

Adjusts the overall image and background brightness.

14 MUTE Button

Mutes the monitor's audio and video output.

Press it again to unmute the monitor's audio and video output. See "Mute Setting" on page 69 for details.

15 PICTURE MODE Button

Cycles through the picture modes [Native], [Retail], [Conferencing], [Highbright], [Transportation] and [Custom]. See page 59.

PICTURE MODE	PURPOSE
Native	Standard setting.
Retail	Bright, vivid colors ideal for advertising and branding.
Conferencing	Lower color temperature and optimized for natural human complexions.
Highbright	Maximum backlight brightness with higher color temperature for brighter ambient environments.
Transportation	Maximum backlight brightness with high contrast to read text under all conditions.
Custom	Custom setting.

TIP: • Changing any of the settings of the [Picture mode] in the OSD menu will change the settings for the current input only.

16 ASPECT Button

Cycles through the picture aspect ratios [Normal], [Full], [Wide], [1:1] and [Zoom]. See page 25.

17 REMOTE ID Button

Activates the REMOTE ID function. See page 43.

18 IMAGE FLIP Button

Rotates the OSD menu and the image when [HOME] is the selected input signal. Cycles through the image flip modes [Landscape], [Portrait], and [180°Rotate]. See page 70.

19 GUIDE Button

Opens the monitor information. See page 71.

■Setting the Aspect Ratio

Press the ASPECT button on the remote control to cycle through the options available for the current input signal.

[Normal] → [Full] → [Wide] → [1:1] → [Zoom]



Aspect ratio of image	Unchanged view* ³	Recommended selection for picture aspect* ³	Description
4:3		[Normal]	Reproduces the aspect ratio that is sent from the source.
Squeeze		[Full]	Fills the entire screen.
Letterbox		[Wide]	Expands a 16:9 letter box signal to fill the entire screen.

*³: Gray areas indicate unused portions of the screen.

[1:1]: Shows the image in a 1 by 1 pixel format.

[Zoom]: The zoom function increases the image size, which expands the image beyond the active screen area. The parts of the image outside the active screen area are not shown.

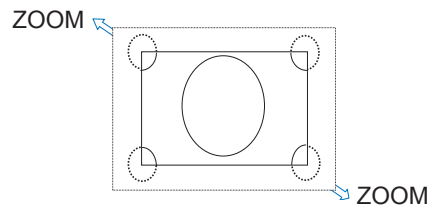

Menu Screen

About the home screen

This screen appears when the HOME button on the remote control is pressed.

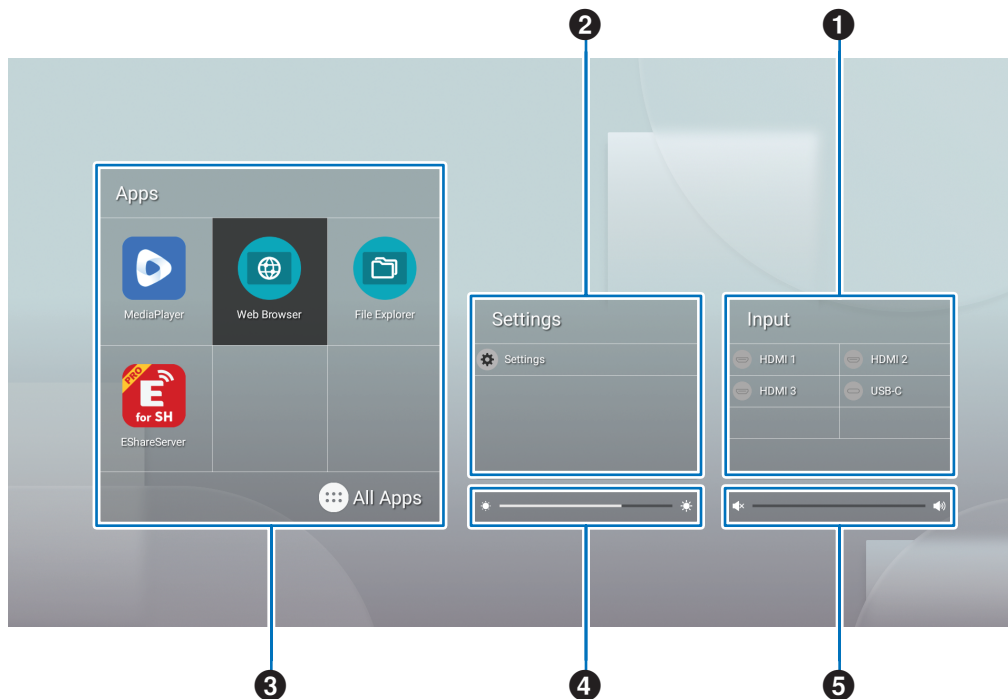

- 1 Changes the input mode.

Input mode	Video	Audio
HOME	HOME	HOME
HDMI1	HDMI1 input terminal	HDMI1 input terminal
HDMI2	HDMI2 input terminal	HDMI2 input terminal
HDMI3	HDMI3 input terminal	HDMI3 input terminal
USB-C	USB Type C port	USB Type C port

The icon for a terminal that is not connected will be grayed out.

- 2 Opens the selected OSD menu for making changes to various settings.



Opens the “Common Settings” menu (See [page 59](#)) and “Administrator Settings” menu (See [page 62](#)).

This accesses the picture and audio settings.

TIP: • Do not turn the main power switch off while the menu is open to avoid discarding the changes to the settings.

1. On the home screen, select [Settings] and press the SET button on the remote control.
2. Select a menu item and then adjust the settings as needed (See [page 59](#)).
3. When finished changing the settings, close the [Common Settings] menu by pressing the EXIT button on the remote control.

TIP: • When pressing the MENU button on the remote control, the [Common Settings] menu may open on the home screen. Close the [Common Settings] menu by pressing the EXIT button on the remote control to operate the application's menu.



Opens the “Administrator Settings” menu (See [page 62](#)).

This accesses the advanced features settings.

TIP: • Do not turn the main power switch off while the menu is open to avoid discarding the changes to the settings.

1. On the home screen, select [Administrator Settings] and press the SET button on the remote control.
2. Select a menu item and configure the settings as needed (See [page 62](#)).
3. When finished changing the settings, close the [Administrator Settings] menu by pressing the EXIT button on the remote control.

TIP: • When pressing the MENU button on the remote control, the [Common Settings] menu may open on the home screen. The [Setting Menu] option can access the [Administrator Settings]. Close the [Common Settings] menu by pressing the EXIT button on the remote control to operate the application’s menu.

3 Opens selected app.



Start [MediaPlayer] (See [page 32](#)).



Start [Web Browser] (See [page 30](#)).



Start [File Explorer] (See [page 28](#)).



Start [EShareServer] (See [page 37](#)).



Show the list of applications.



Show [Updater] (See [page 31](#)).

TIP: • When a confirmation screen to allow access appears when the application is started for the first time, select [Allow].
• When using the “Updater” application, set [Quick Start] to [On]. See [page 67](#).

4 Adjusts the backlight.

5 Adjusts the volume.

Application - File Explorer

Manages the files and folders in the internal storage and the USB flash drive connected to the monitor.

On the home screen, select [File Explorer] and press the SET button on the remote control.

TIP: • For ease of use while following the instructions in this section, connect and use a mouse and keyboard.

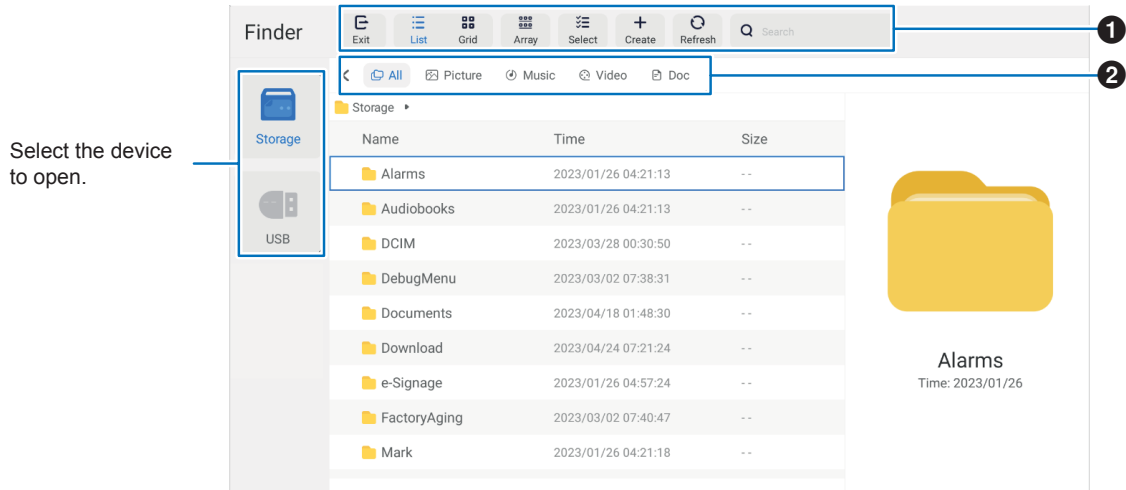

1 Exit

Closes the [File Explorer] application.

List / Grid

Sets the files and folders layout view, options are: list style or icon grid style.

Array

Sorts files and folders by types, options are: Name / Kind / Size / Date Modified.

Select

Checkboxes to select files and folders.

Create

Creates a new folder.

Refresh

Updates the file and folder list.

Search

Input field and search button for searching file and folder names.

2 All

Shows all files and folders.

Picture

Shows the still image files.

Music

Shows the audio files.

Video

Shows the video files.

Doc

Shows the document files.

■ Creating a new folder

1. Select [Create].
2. Input the folder name using the On-Screen keyboard or a connected keyboard.
3. Select [OK].

■Copy/Cut/Paste selected files and folders

1. Select [List] or [Grid] to show files and folders. Then press the SET button on the remote control at [Select].
2. Navigate the cursor to the files or folders that you want to copy or cut and then check the box.
3. Select [Copy] or [Cut], and press the SET button on the remote control.
4. Display the directory that you want to paste and navigate the cursor. Then select [Paste] and press the SET button on the remote control.

■Delete files and folders

1. Select [List] or [Grid] to show files and folders. Then press the SET button on the remote control at [Select].
2. Navigate the cursor to the files or folders that you want to delete and then check the box.
3. Select [Delete], and press the SET button on the remote control.
4. Confirmation window appears. Then select [OK] and press the SET button on the remote control.

■Rename a file and folder

1. Select [List] or [Grid] to show files and folders. Then press the SET button on the remote control at [Select].
2. Navigate the cursor to the file or folder that you want to rename and then check the box.
3. Select [Rename], and press the SET button on the remote control.
4. Input a new name using the On-Screen keyboard or connected keyboard. Then select [OK] and press the SET button on the remote control.

■Close the [File Explorer] window

Select [Exit] on the screen to exit [File Explorer] application and close the window.

Application - Web Browser

1. On the home screen, select [Web Browser] and press the SET button on the remote control.

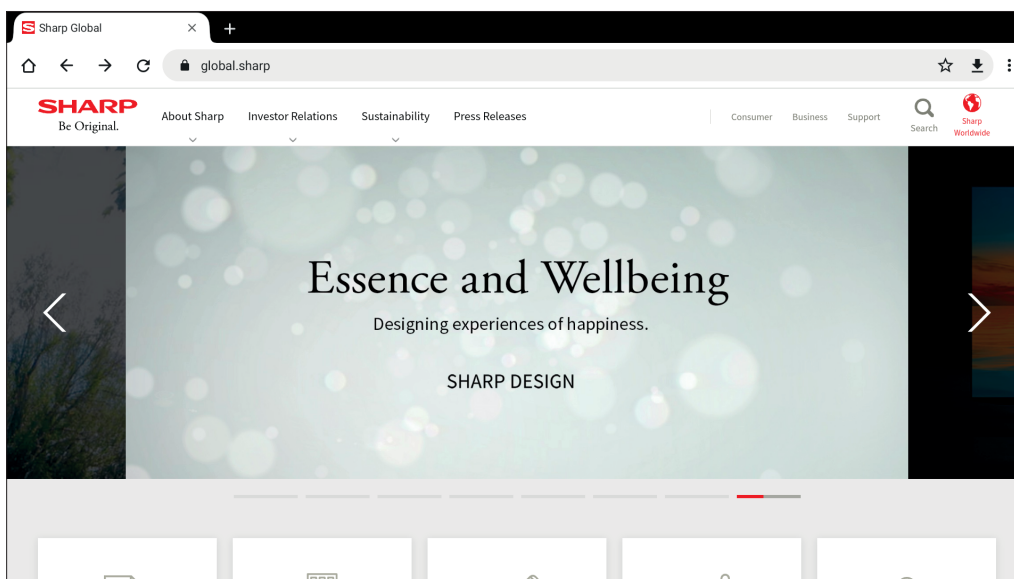

Exiting

Press the EXIT button on the remote control to close the Web Browser.

- TIP:**
- The “Virtual Mouse” will appear on the screen when pressing the MENU button on the remote control for 3 seconds or longer. To move the Virtual Mouse, use the ▲/▼/◀/▶ buttons on the remote control. To select options by pressing the SET button on the remote control.
 - If a large-sized website is displayed, the Web Browser may automatically close.
 - If the application does not work properly, make sure that the date and time are set correctly.

- NOTE:**
- Take proper care when browsing websites.
In a malicious website, the input contents may be stolen and fraudulent applications may be downloaded. If a fraudulent application is installed, it may result in a virus infection or stealing of communication details.
 - Be sure to log out from a website that you have used by logging in.
If you remain logged in, your personal information such as the ID may be known by a third person.

Application - Updater

Updates applications that are factory-installed in APPLICATION. (A network environment that allows access to the internet is required).

On the home screen, select [All Apps], and then select [Updater] by pressing the SET button on the remote control.

The [Export Law Assurances] appears. Select [OK] and press the SET button on the remote control.

To use the software distributed by the [Updater], you must agree to the [Export Law Assurances].

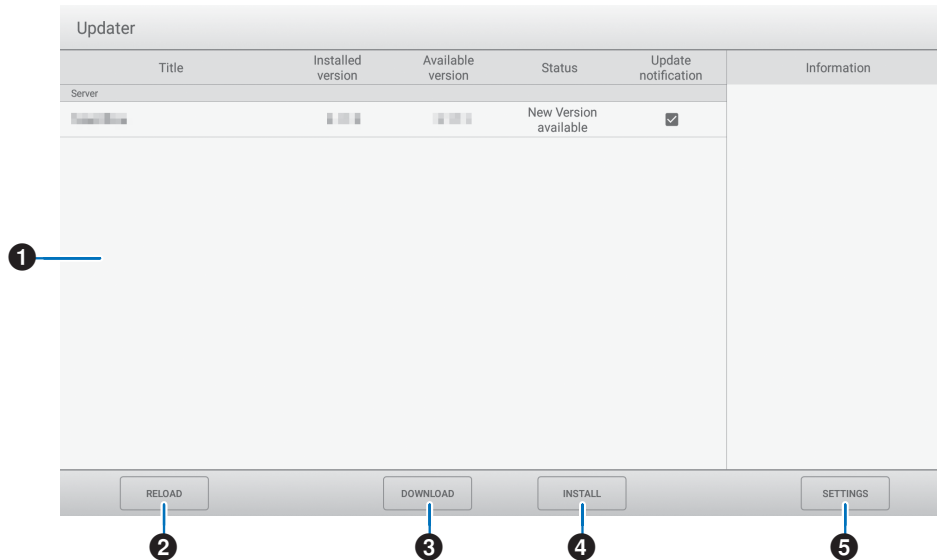

1 Information area

Shows information on already downloaded software and software that can be downloaded.

Update notification: Shown when [Notify new versions] is set to [On]. Update of software that is not checked will not be notified.

2 RELOAD

Refreshes the information in the information area.

3 DOWNLOAD

Downloads the selected software.

4 INSTALL

Installs the selected software.

5 SETTINGS

Configures settings for Updater.

- Hide updated itemsSet whether or not to hide updated softwares in the information area.
- Notify new versionsSet whether or not to display a message if updated software exists.
- Scheduled installationSet whether or not to update the software automatically.
- Scheduled installation dayWhen [Scheduled installation] is set to [On], set the day of week to update the software automatically.
- Scheduled installation timeWhen [Scheduled installation] is set to [On], set the time to update the software automatically.
- ProxySet whether or not to use this monitor in a proxy environment.
- Proxy settingsWhen [Proxy] is set to on, set the host name, port, username, and password of the proxy.
- About UpdaterShow the information about the application.
- ResetInitialize the [SETTINGS].

Application - MediaPlayer

The MediaPlayer is an application for playing playlists composed of multiple image / video / audio files.

Select [MediaPlayer] on the home screen and press the SET button on the remote control.

MediaPlayer top screen

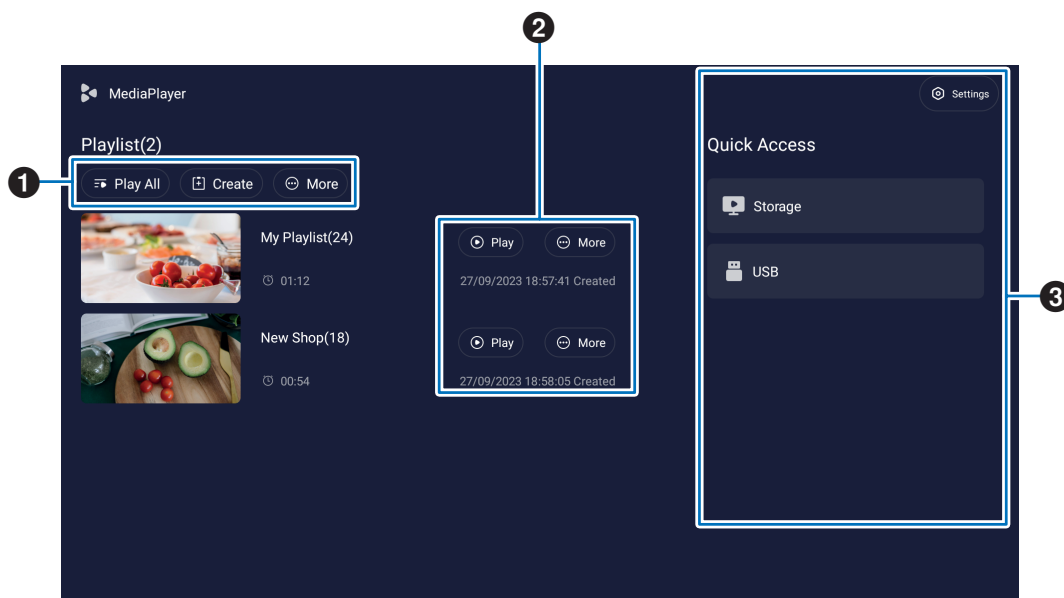

1 Play All

Play all playlists repeatedly from top to bottom.

Create

Create a new playlist.

More

Open additional menu, for example, [Delete all playlist].

2 Play

Plays the playlist shown in the left side.

More

Shows additional menus:

- Enter details..... Show the detail menu. See [page 34](#).
- Delete Delete the playlist.
- Rename Change the name of playlist.
- Upward/Downward Move the selected playlist location on the list.
- Export to USB..... Copy the selected playlist to the folder named "MediaPlayList" on a USB storage device for importing the file to other monitors.

TIP: • The files in the "MediaPlayList" folder will be overwritten.

3 Settings

Configures the MediaPlayer Settings. See [page 34](#).

Storage

Shows a connected device. See [page 35](#).

■Creating a playlist

1. Select [Create]. If there is no playlist, select [Create Playlist] and press the SET button on the remote control.
2. Input a playlist name using the On-Screen keyboard or a connected keyboard.
3. Select [Add the files] on the [Playlist Detail] screen and press the SET button on the remote control.
4. Press the SET button on the remote control at [Select], and then move the cursor to the file that you want to add the playlist. Press the SET button on the remote control.
5. Select [Confirm] and press the SET button on the remote control.

■Playback playlists

- To playback all playlists, select [Play All].
To playback selected playlists, move the cursor to the playlist that you want.
Press the SET button on the remote control.
- To stop playback and close "Playlist Detail" screen, press EXIT button on the remote control.

■Playback screen

It is shown in full screen. Press the SET button on the remote control while playing, the control buttons are displayed at the bottom of the screen. To stop the playback, press the EXIT button on the remote control.



Show the file list and select the file to play.



Set a still image as the monitor's wallpaper. (Only for playing still image files).



/ 7 button on the remote control..... Back 5 seconds. (Only for playing video/audio files).



/ 1 button on the remote control..... Play the previous file.



/ 2 button on the remote control..... Play the selected file.



/ 6 button on the remote control..... Pause playing.



/ 3 button on the remote control..... Play the next file.



/ 9 button on the remote control..... Forward 5 seconds. (Only for playing video/audio files).



Change the repeat pattern.



No repeat.



Repeat the playlist.



Repeat the playing file.

■Editing playlists in Playlist Detail screen

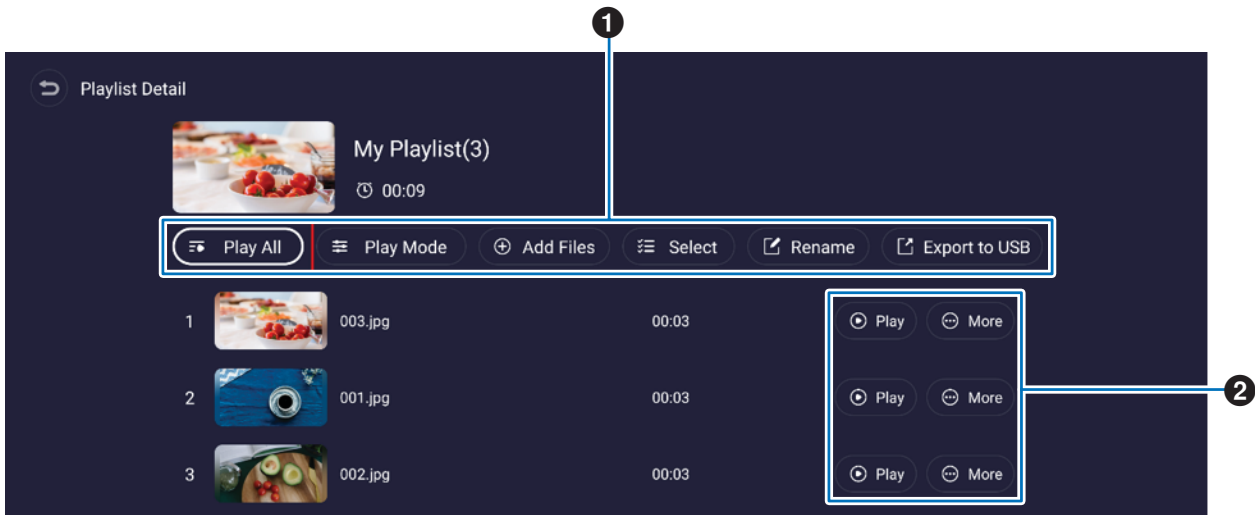

- 1** **Play All**..... Play all files from top-to-bottom.
Play Mode..... Set the repeat play settings and the interval for still image files.
Add Files Add files to the playlist.
Select..... Select and delete files in the playlist.
Rename..... Change the playlist name.
Export to USB Copy the playlist to a USB flash drive.
- TIP:**
- Any existing content in the “MediaPlayList” folder are overwritten.
 - Copying files between a USB flash drive and the internal storage may take some time. Do not turn the main power switch off or let the monitor go into standby power mode while files are copied. Check the settings for [Power Off Schedule] and [Off if No Operation] to ensure the power does not turn off automatically.
- 2** **Play** Play the files in the playlist.
More Change the playlist location upward or downward. Remove a file from the playlist.

■MediaPlayer settings

Set automatic playback and schedule options for the MediaPlayer.

- USB Auto Play** Enables automatic copying of all files on the USB flash drive to the internal storage and playback when a USB flash drive is inserted.
- TIP:**
- Automatically copy files in the “MediaPlayList” folder on the USB flash drive as the new playlist and playback when a USB flash drive is inserted. This function cannot be changed.
 - Copying files between a USB flash drive and the internal storage may take some time. Do not turn the main power switch off or let the monitor go into standby power mode while files are copied. Check the settings for [Power Off Schedule] and [Off if No Operation] to ensure the power does not turn off automatically.
- Schedule Play** Set the playback schedule’s, day, time, and a playlist.
Power On Auto Play Play the playlist automatically when the monitor turns on.
Auto Play When Switch..... Play all playlists automatically in order when pressing the MEDIA PLAYER button on the remote control.
Slideshow Effects..... Sets whether or not to enable the animation effect when changing still images. When disabled, still images switch instantly.

■About Storage screen

Navigate directly to the files in the internal storage or USB flash drive.

Play the files and create playlists quickly.

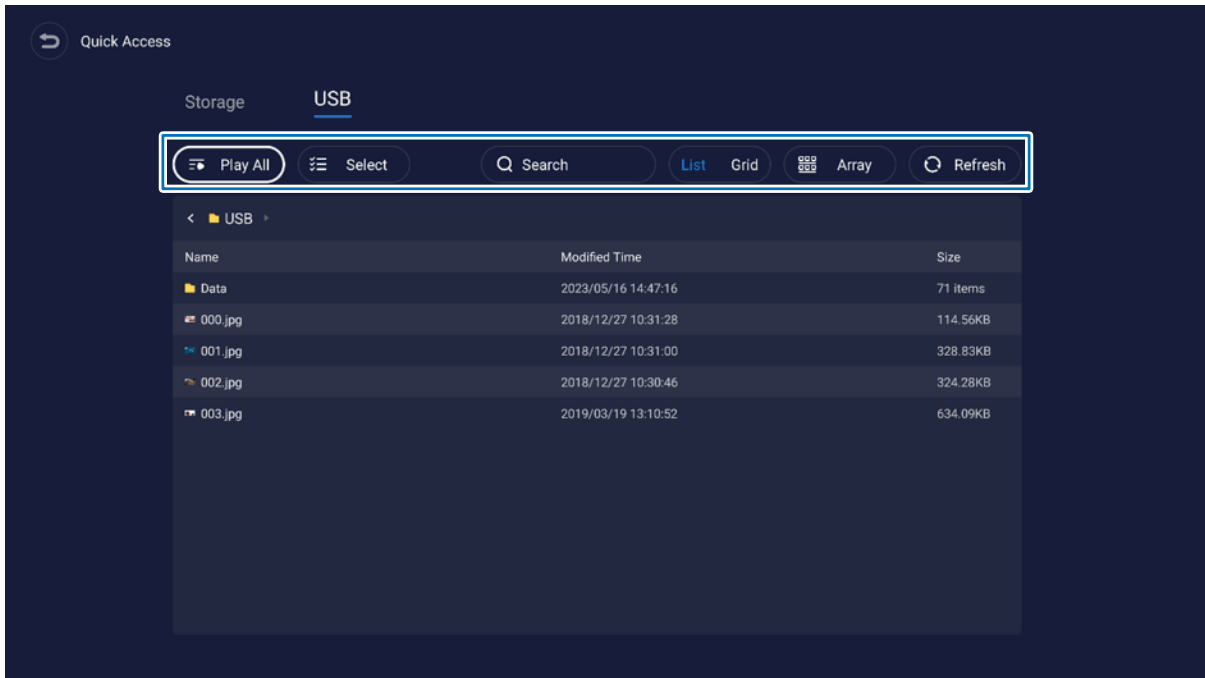

Play All..... Play all files.

Select..... Select the files. Selected files are also available to: play, create a new playlist, add an existing playlist.

Search..... Search for a file with keywords.

List / Grid..... Shows files as a list style or icon style (Grid).

Array Sort files: Name, Kind (file type), Size, Date Modified (update date).

Refresh Update the file list.

Image file

Extension	Max. resolution
*.bmp	7680x4320
.jpg (.jpeg)	
*.png	

TIP: • Still images are shown in 1920 x 1080 resolution.

Audio file

Extension	Audio Codec	Sampling Rate	Bit Rate
*.mp3	MPEG1/2 layer3	8 k ~ 48 kHz	8 k ~ 320 kbps

Video file

Extension	Video Codec	Audio Codec	Max. Resolution	Max. Bit Rate
*.mkv	H.264	Mpeg1/2 Layer1/2/3, AAC-LC	4096x2160@60 fps	135 Mbps
	Mpeg-4		1920x1080@60 fps	40 Mbps
*.mp4	H.265	Mpeg1/2 Layer1/2/3, AAC-LC	4096x2160@60 fps	200 Mbps
	H.264		4096x2160@60 fps	135 Mbps
	Mpeg-4		1920x1080@60 fps	40 Mbps

Sometimes, it may not be possible to play a video file even when the conditions above are met.

File system

File System	Read / Write
FAT32	Read / Write
NTFS	Read

Application - Wireless Display (EShare)

- You can display the image of another device on the same network on this monitor.
- This application can be tried for free. The trial period is 14 days. It cannot be used after the trial period. Please purchase a license key if you wish to continue using it. For details, please contact your authorized SHARP dealer.
- Connect the monitor (with a LAN cable) to a wireless router and the device to the network access point or wireless router.
- Software must be downloaded to the other device.
For details, see below.
- Connections to all devices is not guaranteed.

Supported devices:

Windows	Windows 10 or later
Chrome OS	Eshare: Chrome OS version 126 or later Must support Google Play. Google Cast: Chrome OS version 126 or later
macOS	macOS v13 or later
Android	Android 10 or later
iOS/iPadOS	iOS 14 or later iPadOS 14 or later

■Start EShareServer

To use this application, it is necessary to authenticate. Uses the Internet for authentication. Therefore, when starting this application for the first time, connect this monitor to the Internet.

1. Select  in the home screen and press the SET button on the remote control.

■Display the image that appears on the other device

The following explanation uses Windows (device) as an example.

1. **Access the address shown in EShare on the monitor with your browser, and download the software to the other device whose image is to be displayed.**
A warning screen may be displayed, but continue downloading.
2. **Install and start the software you downloaded.**
3. **Check the name of the display shown in EShare on the monitor and click [Connect].**
4. **Select [Share screen].**
 - You can select [Screen Mirror] (Windows) or [TV Mirror] (Android) to display the image that appears on the monitor on the other device.
 - The other device connects to the monitor, and the image from the other device appears on the monitor.

TIPS

- The manual for this application can be downloaded from our website. (Provided only In English).
<https://business.sharpusa.com/product-downloads> (North America)
<https://www.sharp.eu/download-centre> (Europe/Asia/Pacific)

Advanced Operation

Creating a Power and Reboot Schedule

The schedule function allows the monitor to automatically change between power on and standby state at different times and reboot.

To program the schedule:

1. Enter the [Schedule] menu.

- ① Press the MENU button on the remote control.
- ② Use the ▼ and ► buttons to select [Schedule] in [Administrator Settings] menu. Press the SET button. Input the admin password if required.

2. Set the Power On Schedule.

- ① Use the ►/▲/▼ buttons to select [Add Power On schedule] in [Power On Schedule]. Press the SET button.
- ② Use the ▲/▼ buttons to set the time. To move the setting field, press ◀/▶ buttons.
- ③ Select the [Input] that will become active at the schedule time.
- ④ Select the day(s) that will activate the schedule.
- ⑤ Press ▼ and ► button to select [Save]. Press the SET button.

3. Set the Power Off Schedule.

- ① Use the ►/▲/▼ buttons to select [Add Power Off schedule] in [Power Off Schedule]. Press the SET button.
- ② Use the ▲/▼ buttons to set the time. To move the setting field, press ◀/▶ buttons.
- ③ Select the day(s) that will activate the schedule.
- ④ Press ▼ and ► button to select [Save]. Press the SET button.

4. Set the Reboot Schedule.

- ① Use the ►/▲/▼ buttons to select [Add Reboot schedule] in [Reboot Schedule]. Press the SET button.
- ② Use the ▲/▼ buttons to set the time. To move the setting field, press ◀/▶ buttons.
- ③ Select the day(s) that will activate the schedule.
- ④ Press ▼ and ► button to select [Save]. Press the SET button.

5. Manage the schedules.

- ① Use the ►/▲/▼ buttons to select [Schedule List] in [Schedule]. Press the SET button.
- ② Use the ▲/▼ buttons to select the schedule that you want to change. To enable or disable, press ◀/▶ buttons. If you want to change the time, day(s), or delete the schedule, press the SET button to open the detailed setting window.
- ③ To close the menu, press the EXIT button.

- TIP:**
- The [Date & Time] needs to be set before adding schedules.
 - Schedules you configure are saved when pressing [Save] on the each setting menu.
 - The [Input] in [Power On Schedule] has a higher priority than [Custom Detect] setting.
 - When using the schedule function to turn off, turn on, or reboot, the input set in [Input Change] will take priority and be shown. If the same image does not show before activating the schedule function, please set the input signal again.
 - Each schedule must be set at an interval of 5 minutes or more.
 - Up to 15 "Schedule" items can be created.
 - When a period of about two weeks has passed after disconnecting the power cord of the monitor, the time will be initialized and the clock function will stop. If the clock function has stopped, configure the [Date & Time] again.

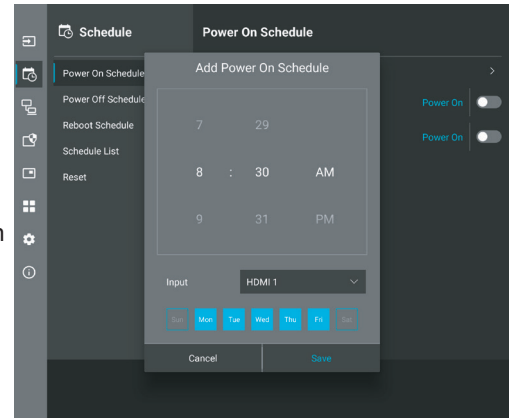

Setting Security and Locking the Monitor Controls

Under normal operation, the monitor can be controlled by any person using the remote control or the monitor control panel. You can prevent unauthorized use and changes to the monitor settings by enabling the options for Security and Lock Settings.

The security and locking functions covered in this section are:

- Setting the password
- Enabling password security
- Locking the remote control buttons (See [page 41](#))
- Locking the monitor rear side buttons (See [page 42](#))

Settings Location

The instructions in this section guide you through configuring security and locking functions in the monitor's OSD menu. These settings can also be configured using the monitor's web controls. See [page 48](#).

The menu options for Security and Lock Settings are in the [Protect] menu in both the OSD menu and web controls.

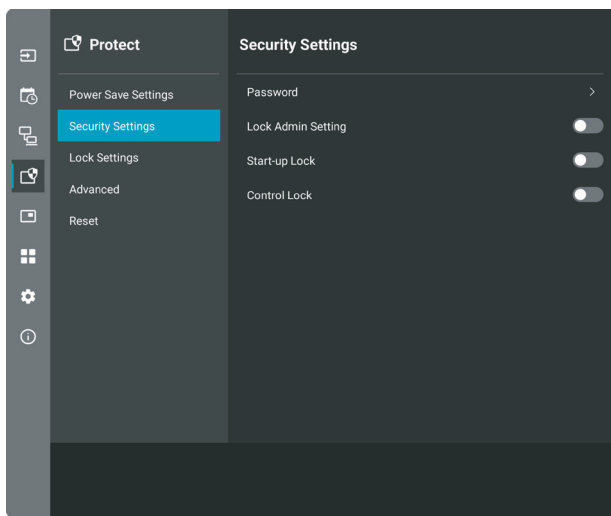

■ Password Security

When password security is enabled, an alphanumeric password between 4 and 64 single-byte is required when turning on the main power and/or accessing the [Administrator Settings] menu (see [page 40](#)). The monitor will function normally after the password is entered. If no buttons are pressed during the period you set for [OSD Time], the monitor will be locked automatically and the password will be required again.

- TIP:**
- If you change the password make a note of the password in a secure location. If you forget your password, you will need to contact technical support to get a recovery password to access the monitor's OSD menu.

Set a password for the monitor

This step is only required if you want to change the password.

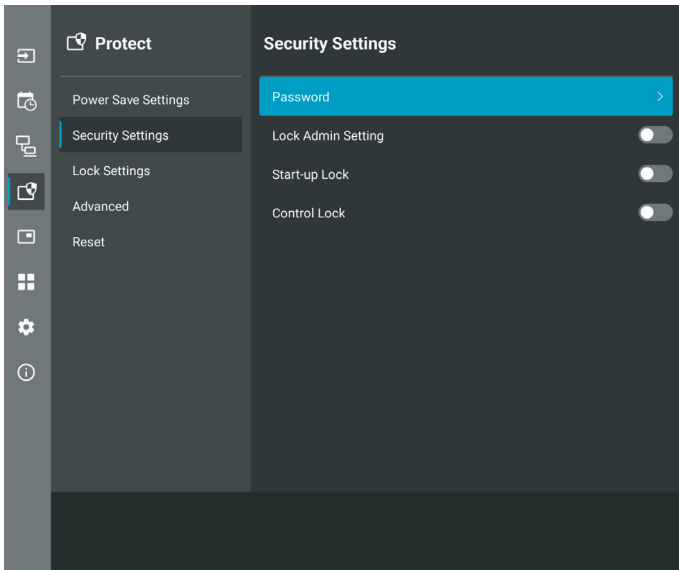

1. Using the remote control, navigate to [Protect] then to [Security Settings]. Select [Password], press OK.
2. Input an admin password and press [OK]. Then you can set other options in [Security Settings].
3. To change the password, under [Change the admin password], enter the current password and press [OK].
4. Input a [Enter new password] field and then input it again in the [Confirm new password] field.
5. The new password is immediately saved.

Enable password security

1. Using the remote control, navigate to [Protect] then to [Security Settings].
2. Select the options you want to use:
 - **[Lock Admin Setting]**The password is required to enter the [Administrator Settings] menu.
 - **[Start-Up Lock]**The password is required when turning on the monitor from the main power switch.
When this option is selected the password is only required on power cycle using the main power switch or after power failure. This option does not prompt for a password when using the remote control POWER ON and STANDBY buttons or the  button on the rear side of the monitor.
 - **[Control Lock]**The password is required to use any of the remote control buttons or buttons on the monitor.

TIP: • The settings are enabled after OSD menu is closed and the specified time has passed that you set in [OSD Time].

■ Locking the Button Controls

The lock settings prevent the monitor from responding to button presses on the IR remote control or the rear side of the monitor. When locking the button controls, some buttons can be configured to remain unlocked for users to adjust the settings. Locking and unlocking the button controls do not require a password.

■ Locking the IR Remote Buttons

Locking

The [IR] option in the [Lock Settings] prevent the monitor from being controlled using the remote control. Enabling [IR] does not lock the buttons on the monitor control panel.

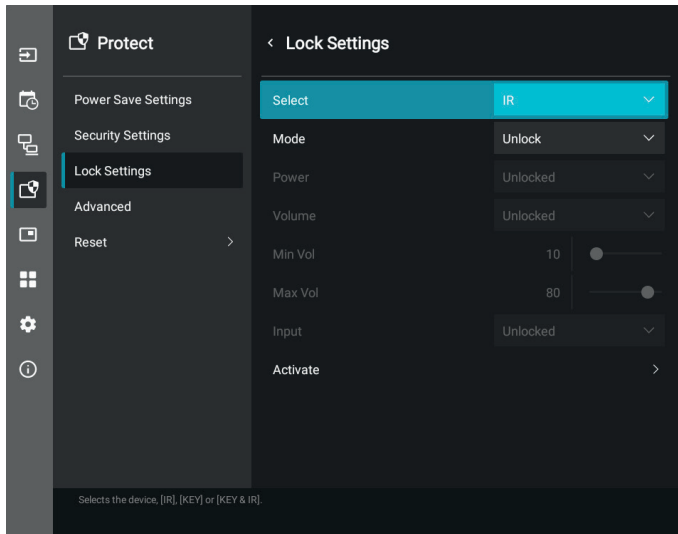

1. Using the remote control, navigate to [Protect] then to [Lock Settings].
 2. Under the [Select] option, press the ▲, ▼ buttons to change the setting to [IR].
 3. Under [Mode] choose the lock mode you want to enable.
 - [Unlock].....All buttons are unlocked.
 - [All Lock].....All buttons are locked.
 - [Custom Lock].....All remote buttons are locked except for the following buttons that can be individually set as locked or unlocked.
 - [Power] Select [Unlocked] to be able to use the  button when the IR Remote is locked. Select [Locked] to lock the button.
 - [Volume] Select [Unlocked] to be able to control the volume with the VOL+, VOL– buttons when the IR Remote is locked. Select [Locked] to prevent volume adjustment.
 - [Min Volume] and [Max Volume]..... The volume buttons are unlocked, and the volume level can only be adjusted within the [Min] and [Max] range set.
The [Volume] must be set to [Unlocked] for this setting to operate.
 4. Select [Activate] to activate all settings.
- TIP:** • Volume [Min Volume]/[Max Volume] lock only works with Internal speaker, Speaker Out connector and Audio Line Out (3.5 mm connector). It does not work when [Audio Receiver] is enabled.
- [Input] Select [Unlocked] to unlock all input buttons. Select [Locked] to lock all input buttons.

Unlocking

- IR Remote Control – to return to normal operation, press-and-hold the DISPLAY button for at least 5 seconds.

■ Locking the rear side Buttons

Locking

The [Key] option in the [Lock Settings] prevents the monitor from being controlled using the buttons on the rear side of the monitor. Enabling [Key] does not lock the buttons on the remote control.

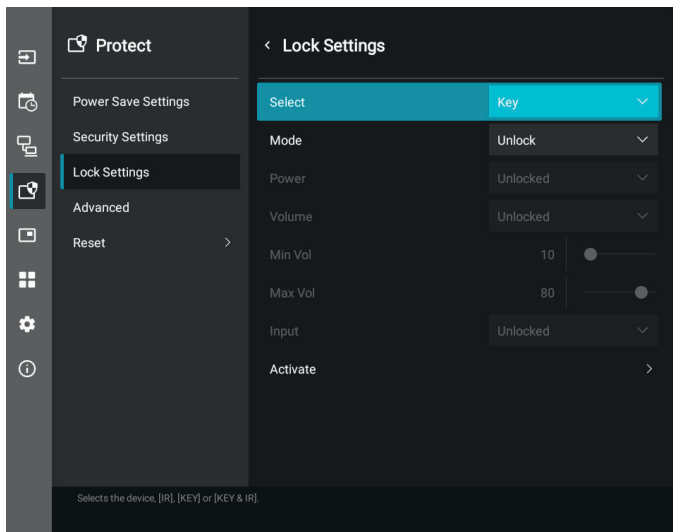

1. Using the remote control, navigate to [Protect] then to [Lock Settings].
2. Under the [Select] option, press the ▲, ▼ buttons to change the setting to [Key].
3. Under [Mode] choose the lock mode you want to enable.
 - [Unlock]..... All buttons are unlocked.
 - [All Lock]..... All buttons are locked.
 - [Custom Lock]..... All buttons are locked except for the following buttons that can be individually set to be locked or unlocked.
 - [Power] Select [Unlocked] to be able to use the ⏻ button when the keys are locked.
 - [Volume] Select [Unlocked] to be able to control the volume with the </> keys when the keys are locked. Select [Locked] to prevent volume adjustment.
 - [Min Volume] and [Max Volume]..... The </> keys are unlocked and the volume can only be adjusted within the [Min] and [Max] set.
The [Volume] must be set to [Unlocked] for this setting to operate.
TIP: • Volume [Min Volume]/[Max Volume] lock only works with Internal speaker, Speaker Out connector and Audio Line Out (3.5 mm connector). It does not work when [Audio Receiver] is enabled.
 - [Input] Select [Unlocked] to be able to change the inputs using the INPUT button.
4. Select [Activate] to activate all settings.

Unlocking

Buttons To return to normal operation unlock all the buttons on the rear side of the main unit by pressing the ▲ button and ▼ button on the main unit control panel at the same time for 3 seconds or longer.

OSD Menu.... To return to normal operation, use the remote control to navigate to [Protect] then to [Lock Settings]. Under the [Select] option, change the setting to [Key]. Under [Mode] choose [Unlock] and then select [Activate].

■ Locking the IR Remote Buttons and the rear side Buttons

Select [Protect] → [Lock Settings] → [Select] → [Key & IR] from the OSD menu.

For the subsequent setting procedure, buttons for which the lock is enabled, and unlocking method, refer to “[Locking the IR Remote Buttons](#)” and “[Locking the rear side Buttons](#)”.

Setting the Remote Control ID Function

The remote control can be used to control up to 25 individual MultiSync monitors using what is called the REMOTE CONTROL ID mode. The REMOTE CONTROL ID mode works in conjunction with the Monitor ID, allowing control of up to 25 individual MultiSync monitors. For example, if there are many monitors being used in the same area, a remote control in normal mode would send signals to every monitor at the same time (see **Figure 1**). Using the remote in REMOTE CONTROL ID mode will only operate one specific monitor within the group (see **Figure 2**).

To Set Remote Control ID (Entering REMOTE CONTROL ID mode)

While holding down the REMOTE ID SET button on the remote control, use the KEYPAD to input the Monitor ID (1-25) of the monitor to be controlled via remote. The remote control can then be used to operate the monitor having that specific Monitor ID number.

When 0 is selected or when the remote control is in normal mode, all monitors will be operated.

To Reset REMOTE CONTROL ID mode

Normal Mode - To return to Normal Mode press the REMOTE ID CLEAR button and hold down for 5 seconds.

- TIP:**
- In order for this feature to work properly, the monitor must be assigned a Monitor ID number. The Monitor ID number can be assigned under the Setup menu in the OSD. See [page 69](#).
 - Point the remote control toward the remote sensor of the desired monitor and press the REMOTE ID SET button. The MONITOR ID number is shown on the screen when your remote control is in ID mode.

Use the Remote Control to Control all Monitors in Range

1. On the remote control, press and hold down the REMOTE ID SET button while using the keypad to input the REMOTE CONTROL ID number "0".
2. All monitors within range of the remote control will now respond to keypad press.

- TIP:**
- When the REMOTE ID is set to "0", pressing REMOTE ID SET will make all monitors, within range of the remote signal, show their Monitor ID on screen. This way you can easily see what the Monitor ID is if you want to control a single monitor, as described below.

Use the remote control to operate a monitor that has a specific MONITOR ID number assigned to it

1. Set the [Monitor ID] number for the monitor (see [page 69](#)). The [Monitor ID] number can range from 1-25.
This [Monitor ID] number allows the remote control to operate this specific monitor without affecting other monitors.
2. On the remote control, press and hold down the REMOTE ID SET button while using the keypad to input the REMOTE CONTROL ID number (1-25). The REMOTE ID NUMBER should match the MONITOR ID number of the monitor to be controlled.
3. Point the remote control toward the remote sensor of the desired monitor and press the REMOTE ID SET button.

The MONITOR ID number is shown in red on the monitor.

If the REMOTE CONTROL ID is "0", then all monitors in range will show their particular MONITOR ID number in red.

If the MONITOR ID number is shown in white on the monitor, the MONITOR ID number and the REMOTE CONTROL ID are not the same.

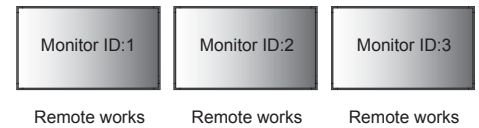

Figure 1
Remote in Normal mode or the REMOTE ID is set to 0

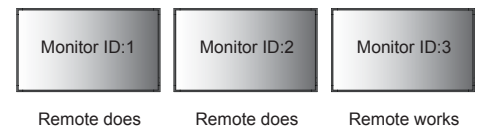

Figure 2
Remote set up to use REMOTE ID:3

You need a remote control for this function.

Connecting Multiple Monitors

[Setup] > [Tile Matrix] allows one image to be expanded and shown over multiple screens (up to 25) through a distribution amplifier.

- [H Monitors] ... Number of monitors arranged horizontally.
- [V Monitors].... Number of monitors arranged vertically.
- [Position] Sets the section of the tiled image to view on the current monitor.
- [Tile Comp]..... Scales the image to compensate for the width of the screen bezel in order to create a seamless image.

Example of Tile Matrix 2x2

For the monitor on top:

1. Set H Monitors [2] and V Monitors [2].

One image will be divided by 4 then put number from 1 to 4.

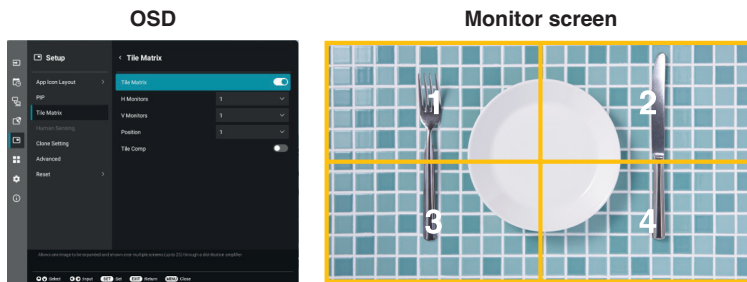

2. Select 1 to 4 at [Position].

e.g. Selecting 1

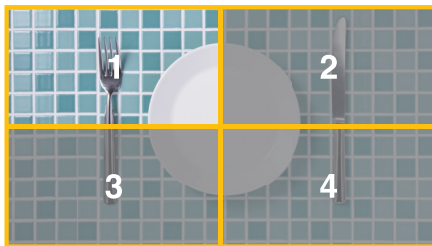

External Control

Connecting an external device

There are two options to connect an external device to control the monitor.

- RS-232C terminal.
Connecting an external device to the RS-232C terminal of the monitor with an RS-232C cable.
- LAN port.
Connecting a network to the LAN port of the monitor with a LAN cable (RJ-45 category 5 or higher).

Controlling the Monitor via RS-232C

This monitor can be controlled by connecting a personal computer with an RS-232C (reverse type) terminal.

For example, some of the functions that can be controlled by a personal computer are:

- Power ON or standby.
- Switching between input signals.
- Sound Mute ON or OFF.

Connection

Monitor + computer.

- Please turn off the monitor's main power before connecting a computer to the monitor.
- Please turn on the connected computer first then turn on the monitor's main power.

If you turn on the computer and monitor in reverse order, the com port may not work.

To control the monitor via commands sent from a computer connected with an RS-232C cable, please use the control command. Instructions for the control command can be found in the "External_Control.pdf". See [page 57](#).

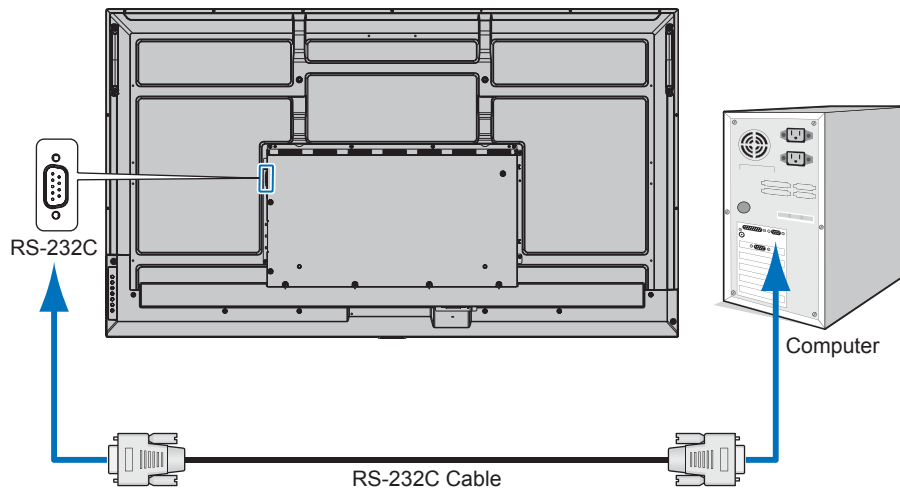

- TIP:**
- If your computer is equipped only with a 25-pin serial port connector, a 25-pin serial port adapter is required. Contact your supplier for details.
 - For the pin assignment, please see "RS-232C input/output" on [page 46](#).

This monitor uses RXD, TXD and GND lines for RS-232C control.

The reverse type cable (null modem cable) (not included) should be used for RS-232C control.

PIN ASSIGNMENT

RS-232C input/output

Pin No	Name
1	NC
2	RXD
3	TXD
4	NC
5	GND
6	NC
7	NC
8	NC
9	NC

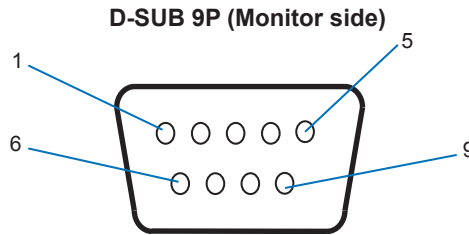

This monitor uses RXD, TXD and GND lines for RS-232C control.

Controlling the Monitor via LAN

Connecting to a Network

Using a LAN cable allows you to specify the monitor Settings by using an HTTP server function.

TIP: • To use a LAN connection, you are required to assign an IP address (see [page 64](#)). The monitor will obtain an IP address automatically when connected to a DHCP network.

Example of LAN connection:

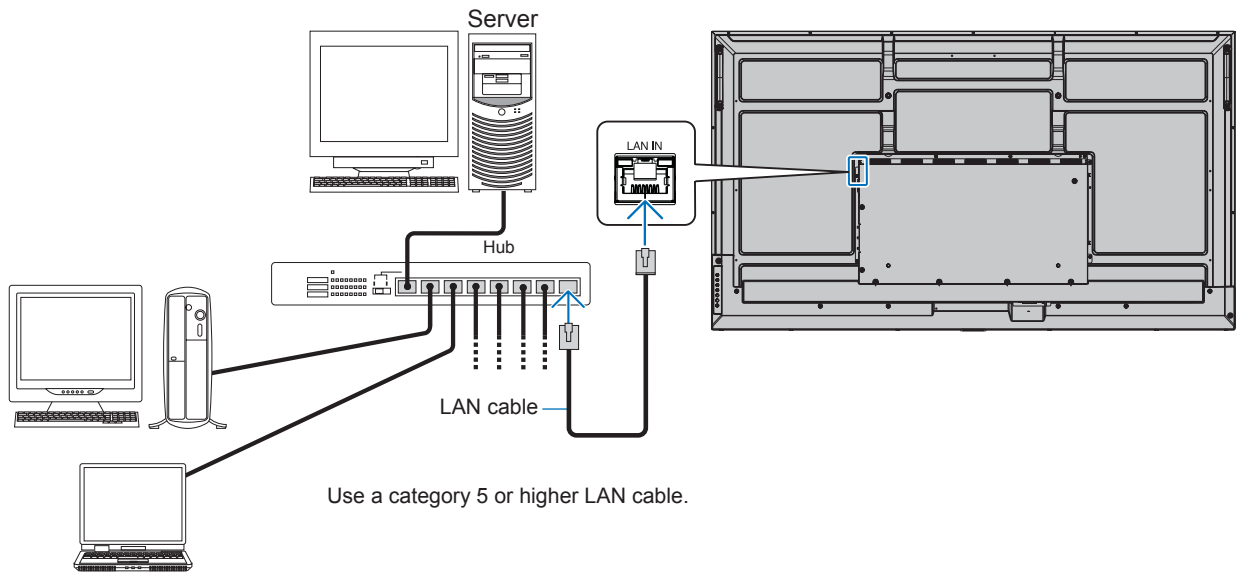

TIP: • This monitor must be connected to a network.
Enables [Monitor Control via Network] in [Network Settings] of [Network] on the [Administrator Settings] menu.

• The HTTP server won't work when [Low Power] is set to [Mode] under [Power Save Settings] in [Protect].
When using the HTTP server function with the power off, make sure to set [Mode] to [Normal].

■HTTP Browser

Overview

Connecting the monitor to a network allows for remote control of the monitor from a computer connected to the same network.

This device uses “JavaScript” and “Cookies” and the browser should be set to accept these functions. Refer to the help files for the web browser to change the settings to use JavaScript and Cookies.

To access the HTTP server, launch a web browser on a computer connected to the same network as the monitor and enter the following URL in the web address field:

Network Setting

`https://<the Monitor's IP address>/index.html`

- TIP:**
- The default IP address is assigned automatically to the monitor.
 - NaViSet Administrator software for managing monitors over the network is recommended (See [page 57](#)).
 - If the MONITOR NETWORK SETTINGS screen does not appear in the web browser, press the Ctrl+F5 keys to refresh your web browser (or clear the cache).
 - If the monitor appears to be slow in response to commands or clicks on buttons in the browser, or the general speed of operation is unacceptable, this may be due to network traffic or the settings on your network. Should this happen, consult your network administrator.
 - The monitor may not respond if the buttons shown on the browser are repeatedly pressed in rapid intervals. Should this happen, wait a moment and repeat. If you still can't get a response, turn the monitor off and then back on.

Preparation Before Use

Operation with a browser that uses a proxy server may not be possible depending on the type of proxy server and the setting method. Although the type of proxy server will be a factor, it is possible that items that have been set will not be shown, depending on the effectiveness of the cache, and the contents set from the browser may not be reflected in operation. It is recommended that a proxy server is not used unless the network environment requires it.

Handling of the Address for Operation via a Browser

A host name can be used in the following cases (corresponding to the IP address of the monitor):

The host name must be registered in the domain name system (DNS) by the network administrator. You can then access the network settings of the monitor via this registered host name by using a compatible browser.

If the host name has been configured in the “HOSTS” file of the computer being used, you can then access the network settings of the monitor via this host name by using a compatible browser.

Example 1: When the host name of the monitor has been set to “pd.xxx.co.jp”, access is gained to the network setting by specifying `https://pd.xxx.co.jp/index.html` for the address or the entry column of the URL.

Example 2: When the IP address of the monitor is “192.168.73.1”, access is gained by specifying `https://192.168.73.1/index.html` for the address or the entry column of the URL.

Setup for first-time use of the HTTP server

ENTER NEW HTTP PASSWORD window opens when accessing the HTTP server for the first time.

Set a password for the HTTP server. The password can be max. 32 characters.

Operation

Access the following address to show HOME.

https://<the Monitor's IP address>/index.html

Click each link on the left-hand column below HOME.

REMOTE CONTROL

Enable an operation to control the monitor equivalent to the keys on the remote control.

■OSD Menu Settings in the Monitor Web controls

Select one of the links on the left side of the monitor web controls to configure the settings available in the monitor's OSD. Please see [page 59](#) for the full list of OSD menu controls.

[Picture], [Audio], [Input & Output], [Schedule], [Network], [Protect], [Setup], [System]

The screenshot shows the SHARP monitor web controls interface. On the left is a navigation menu with the following items: HOME, REMOTE CONTROL (highlighted), PICTURE, AUDIO, INPUT&OUTPUT, SCHEDULE, NETWORK, CRESTRON CONNECTED, PROTECT, SETUP, SYSTEM, SNMP, NAME, NETWORK SERVICE, and UPDATE FIRMWARE. The main content area is titled 'REMOTE CONTROL' and contains several settings sections:

- POWER:** Radio buttons for On and Off.
- INPUT SELECT:** Radio buttons for HOME, USB-C, HDMI 1, HDMI 2, and HDMI 3.
- PICTURE MODE:** Radio buttons for Native, Transportation, Retail, Custom, Conferencing, and Highbright.
- ASPECT:** Radio buttons for Normal, Full, Wide, and 1:1.
- MUTE:** Radio buttons for On and Off.

At the bottom of the settings area are three buttons: APPLY, RELOAD, and RESET.

TIP: • The buttons in the monitor web controls function as follows:

[APPLY]..... Saves the settings.

[CANCEL] Returns to the previous settings.

TIP: • CANCEL is disabled after clicking APPLY.

[RELOAD] Reloads the settings.

[RESET] Resets to the initial settings.

■SNMP Settings

Click on "SNMP" on the left-hand column below HOME.

The SNMP protocol is used to get status information and to control a monitor directly via the network.

Version:

SNMP v1 Authenticated plaintext by community name, does not return a confirmation message of the trap.

SNMP v2c Authenticated plaintext by community name, returns a confirmation message of the trap.

SNMP v3 User authentication and message encryption are performed using an authentication protocol.

Community name:

The default setting of community name is “public”. It is read-only. You can set community names for up to 3 settings. When “SNMP v3” is selected in “Version”, configure the settings below.

USER NAME 1-3

USER1 to 3 can be registered.

USER NAME Configure the username to be used in SNMPv3.

SECURITY LEVEL Set the security level.

SECURITY LEVEL	Authentication protocol	Message encryption
No Auth/No Private	No (User name)	No
Auth/No Private	MD5 or SHA1	No
Auth/Private	MD5 or SHA1	DES or AES

Trap:

Sending error message to a specified address when an error occurs in the monitor.

Check Box	Explanation	Error code
Temperature	Temperature abnormal	0xA0, 0xA1, 0xA2

Name Settings

Click on “NAME” on the left-hand column below HOME.

MONITOR NAME	Allows you to customize the monitor’s name, up to a maximum of 16 characters long. This name is shown when searching for devices on the network when using an application such as NaViSet Administrator. Giving the monitor a unique name allows it to be easily identified when viewing a list of monitors on the network. The default name is the monitor’s model name.
HOST NAME	Type in the hostname of the network to the monitor. Up to 15 alphanumeric characters can be used.

Network Service Settings

Click on “NETWORK SERVICE” on the left-hand column below HOME.

PJLink CLASS	Set a class for PJLink*. NOTE: PJLink is a network interface standard that JBMA established. https://pjlink.jbma.or.jp/index.html This monitor is available for class1 and class2 command.
NOTIFY FUNCTION ENABLE	Enable or disable a notification of the monitor network condition. This function is only for class2.
NOTIFY ADDRESS	Set an IP ADDRESS to which the monitor network status will be sent. This function is only for class2.
PJLink PASSWORD	Set a password for PJLink*. The password must be max. 32 characters long. Do not forget your password. If you forget your password, consult your supplier.
HTTP PASSWORD	Set a password for the HTTP server. The password must be max. 32 characters long.
HTTP PASSWORD ENABLE	An HTTP PASSWORD is required when logging into the HTTP server. Set the monitor name as the USER NAME when entering the password.

*What is PJLink?

PJLink is a standardization of protocol used for controlling devices of different manufacturers. This standard protocol was established by Japan Business Machine and Information System Industries Association (JBMA) in 2005.

The device supports all commands of PJLink.

Commands

Connecting the monitor with RS-232C or connecting to a network via LAN, the control commands transmit and receive between the monitor and a connected device. It allows for remote control of the monitor from a connected device. Instructions for both control command types can be found in the external documents.

For details of each command, see the manual on the following website.

<https://sharp-displays.jp.sharp/global/index.html>

Proof of Play

This function allows sending of messages for the current status of the monitor by self-diagnosis.

For the Proof of Play function including self-diagnosis, please see the “External_Control.pdf”. See [page 57](#).

Check item		Message
①	INPUT	HDMI1, HDMI2, HDMI3, USB-C, HOME
②	Resolution	e.g. (H)1920, (V)1080, (H)3840, (V)2160 or No signal or Invalid signal
③	Picture Image	Normal Picture or No Picture
④	AUDIO OUT	Normal Audio or No Audio
⑤	TIME	(year)/(month)/(day)/(hour)/(minutes)/(second)
⑥	EXPANSION DATA	01h: AC Power On 02h: DC Power On 03h: DC Power Off 10h: MEDIA PLAYER is stop 11h: MEDIA PLAYER is start 12h: MEDIA PLAYER is pause 13h: MEDIA PLAYER error occur 40h: Human detected (Human sensor Status) 41h: Human detect cleared (Human Sensor Status)

Example:

- ① HDMI1
- ② 3840 x 2160
- ③ Normal Picture
- ④ Normal Audio
- ⑤ 2020/1/1/0h/0m/0s
- ⑥ 10h: MEDIA PLAYER is stop

Troubleshooting

Screen Image and Video Signal Issues

No picture

- The signal cable should be completely connected to the display card/computer.
- The display card should be completely seated in its slot.
- Check the main Power Switch, it should be in the ON position.
- Make sure both the computer and monitor are powered on.
- Make sure that a supported resolution has been selected on the display card or system being used. If in doubt, please refer to the user's manual of the display controller or system to change the resolution.
- Check the monitor and your display card with respect to compatibility and recommended signal timings.
- Check the signal cable connector for bent or pushed-in pins.
- The monitor automatically goes into standby at the preset time period after the video signal is lost. Press the power on button on the remote control or press the  button on the monitor.
- If you unplug the signal cable when starting the computer, images may not be shown. Turn off the monitor and the computer and then connect the signal cable and turn on the computer and the monitor.
- Check for HDCP (High-bandwidth Digital Content Protection) content. HDCP is a system for preventing illegal copying of video data sent over a digital signal. If you are unable to view material via the digital inputs, this does not necessarily mean that the monitor is not functioning properly. With the implementation of HDCP, there may be cases in which certain content is protected by HDCP and might not be shown due to the decision/intention of the HDCP community (Digital Content Protection, LLC).

Image persistence

- Please be aware that LCD Technology may experience a phenomenon known as image persistence. Image persistence occurs when a residual or "ghost" image of a previous image remains visible on the screen. Unlike CRT monitors, the image persistence of monitors is not permanent, but a single still image being shown for a long period of time should be avoided. To alleviate image persistence, put the monitor into standby via remote control or turn the monitor's main power off for as long as the previous image was shown. For example, if an image was on the monitor for one hour and a residual image remains, the monitor should be in standby or turned off for one hour to erase the image.

- TIP:**
- As with all personal display devices, we recommend showing moving images, or changing still images at regular intervals whenever the screen is idle, or putting the monitor into standby or turning it off when not in use.

The image is blinking

- If you use a signal repeater or distributor or a long cable, this may cause image roughness or blink for a moment. In this case please connect the cable to the monitor directly without using a repeater or a distributor, or replace the cable with a higher quality cable. Using a twisted pair extender may cause image roughness depending on the environment where the monitor is in or the cable you are using. For further information please ask your supplier.
- Some HDMI cables may not show a correct image. If input resolution is 1920 x 2160, 3840 x 2160 or 4096 x 2160, please use an HDMI cable which is approved to support 4K resolution.
- If external noise is affected, please use shielded cables.

The image is unstable, unfocused or swimming is apparent

- The signal cable should be completely attached to the computer.
- Please adjust settings in the [Picture Mode] menu by checking the image on the screen.
- When the display mode is changed, the OSD Image Adjust settings may need to be re-adjusted.
- Check the monitor and your display card with respect to compatibility and recommended signal timings.
- If text looks garbled, change the video mode to non-interlaced and use a 60 Hz refresh rate.
- The image may be distorted when turning the power on or changing the settings.

The image is not properly reproduced

- Use the OSD Image Adjust controls to increase or decrease the coarse adjustment.
- Make sure that a supported resolution has been selected on the display card or system being used.
- If in doubt, please refer to the user's manual of the display card or system to change the resolution.

Selected resolution is not displayed properly

- Check the Information OSD to verify the appropriate resolution has been selected.
- If the resolution you set is over or under a range, an "OUT of RANGE" window will appear in order to warn you. Please set supported resolution at the connected computer.

Video contrast is either too high or too low

- Check that the correct option for the [Video Range] is selected for the input signal. This only applies to video signals on the HDMI and USB-C inputs.
 - Blacks are crushed and whites are clipped - change the [Video Range] to [Raw Signal]. Crushing blacks and clipping whites can occur when the monitor's [Video Range] is set to [Expanded Signal] while the source video signal's color levels are RGB Full (RGB 0-255), causing lost details in the shadows and highlights and the image appears overly high in contrast.
 - Blacks are dark gray and whites are dull - change the [Video Range] to [Expanded Signal]. Dulling blacks and whites can occur when the [Video Range] is set to [Raw Signal] while the source video signal's color levels are RGB Limited (RGB 16-235), which effectively appears to prevent the monitor from obtaining its full brightness range and the image appears to be lacking in contrast.

Either light vertical or horizontal stripes may appear, depending on the specific image pattern. This is not a product fault or degradation.

Hardware Issues

The buttons do not respond

- Unplug the power cord of the monitor from the AC outlet to turn off and reset the monitor.
- Check the main power switch on the monitor.
- The monitor takes approximately 30 seconds or more to start up when the main power switch is turned on. During the startup, operation is not possible. Please wait until the startup is complete.

No sound

- Check to see if the audio cable is properly connected.
- Check to see if [Mute] is active. Use the remote control to enable or disable the mute function.
- Check to see if [Volume] is set to a minimum.
- Check to see if the computer supports an audio signal.
If unsure, contact your supplier.
- If HDMI-CEC audio device is not connected, please set [Audio Receiver] to [Off].

The remote control is not functioning

- The batteries may be drained. Please change the batteries, then check if the remote control works.
- Check that the batteries are inserted correctly.
- Check that the remote control is pointing at the remote control sensor of the monitor.
- Check the status of [Lock Settings].
- The remote control system may not function when direct sunlight or strong illumination strikes the remote control sensor of the monitor, or when there is an object in the path.

The USB Hub does not operate

- Check to make sure that the USB cable is properly connected. Refer to your USB device user's manual.
- Check that the USB upstream port on the monitor is connected to the USB downstream port on the computer. Please make sure the computer is ON or [USB Power] is [On].

USB or RS-232C or LAN control is not available

- Check RS-232C (reverse type) or the LAN cable. A category 5 or higher LAN cable is required for connection.

■Power Indicator Patterns

LED on the monitor is not lit (no blue or red color can be seen) (see [page 20](#))

- Make sure the power cord is properly connected to the monitor and the wall, and make sure the monitor's main power switch is ON.
- Make certain the computer is not in a power-saving mode (touch the keyboard or move the mouse).
- Check that the [Power Indicator] is set to [On] in the [Protect] settings of the OSD menu.

The monitor goes into standby automatically

- Set the [CEC] function to [Off]. The monitor may go into standby state when a connected HDMI-CEC supported device goes into standby.
- Please check [Power Off Schedule] in the [Schedule List].

MediaPlayer function does not recognize the USB storage device

- Check that a USB storage device is connected to the USB port.
- Check the file format of the USB storage device if it is not recognized by the monitor.

LED colors, except for blue, are blinking or glowing

- A certain failure might have occurred, please contact your supplier.
- If the monitor is powered off due to the internal temperature being higher than the normal operating temperature, the LED will blink red six times. Please leave the monitor to cool down for a few minutes then turn it on again.
- The monitor could be in standby.

Press the power on button on the remote control or press the  button on the monitor.

Specifications

Compatible signal list

Signal name	Resolution	Scanning frequency		HDMI		USB-C	Remarks
		Horizontal	Vertical	MODE1	MODE2		
VGA	640 x 480	31.5 kHz	60 Hz	Yes	Yes	Yes	
SVGA	800 X 600	37.9 kHz	60 Hz	Yes	Yes	Yes	
XGA	1024 x 768	48.4 kHz	60 Hz	Yes	Yes	Yes	
HD	1280 x 720	45.0 kHz	60 Hz	Yes	Yes	Yes	
WXGA	1280 x 800	49.7 kHz	60 Hz	Yes	Yes	Yes	
SXGA	1280 x 1024	64.0 kHz	60 Hz	Yes	Yes	Yes	
WXGA	1360 x 768	47.7 kHz	60 Hz	Yes	No	Yes	
	1366 x 768	47.7 kHz	60 Hz	Yes	Yes	Yes	
SXGA+	1400 x 1050	65.3 kHz	60 Hz	Yes	Yes	Yes	
WXGA+	1440 x 900	55.9 kHz	60 Hz	Yes	Yes	Yes	
UXGA	1600 x 1200	75.0 kHz	60 Hz	Yes	Yes	Yes	
WSXGA+	1680 x 1050	65.3 kHz	60 Hz	Yes	Yes	Yes	
Full HD	1920 x 1080	67.5 kHz	60 Hz	Yes	Yes	Yes	
WUXGA	1920 x 1200	74.6 kHz	60 Hz	Yes	Yes	Yes	
4K/2	1920 x 2160	133.3 kHz	60 Hz	Yes	Yes	Yes	
4K	3840 x 2160	54.0 kHz	24 Hz	Yes	Yes	Yes	
	3840 x 2160	56.3 kHz	25 Hz	Yes	Yes	Yes	
	3840 x 2160	67.5 kHz	30 Hz	Yes	Yes	Yes	
	3840 x 2160	112.5 kHz	50 Hz	No	Yes	Yes	
	3840 x 2160	135.0 kHz	60 Hz	No	Yes	Yes	Recommended signal timing
	4096 x 2160	54.0 kHz	24 Hz	Yes	Yes	Yes	Compressed image
	4096 x 2160	56.3 kHz	25 Hz	No	Yes	Yes	Compressed image
	4096 x 2160	67.5 kHz	30 Hz	No	Yes	Yes	Compressed image
	4096 x 2160	112.5 kHz	50 Hz	No	Yes	Yes	Compressed image
4096 x 2160	135.0 kHz	60 Hz	No	Yes	Yes	Compressed image	
HDTV (1080p)	1920 x 1080	27.0 kHz	24 Hz	Yes	Yes	Yes	
	1920 x 1080	28.1 kHz	25 Hz	Yes	Yes	Yes	
	1920 x 1080	33.8 kHz	30 Hz	Yes	Yes	Yes	
	1920 x 1080	56.3 kHz	50 Hz	Yes	Yes	Yes	
	1920 x 1080	67.5 kHz	60 Hz	Yes	Yes	Yes	
HDTV (1080i)	1920 x 1080 (Interlaced)	28.1 kHz	50 Hz	Yes	Yes	No	
	1920 x 1080 (Interlaced)	33.8 kHz	60 Hz	Yes	Yes	No	
HDTV (720p)	1280 x 720	37.5 kHz	50 Hz	Yes	Yes	Yes	
	1280 x 720	45.0 kHz	60 Hz	Yes	Yes	Yes	
SDTV (576p)	720 x 576	31.3 kHz	50 Hz	Yes	Yes	Yes	
SDTV (480p)	720 x 480	31.5 kHz	60 Hz	Yes	Yes	Yes	
SDTV (576i)	720 x 576 (Interlaced)	15.6 kHz	50 Hz	Yes	Yes	No	
SDTV (480i)	720 x 480 (Interlaced)	15.7 kHz	60 Hz	Yes	Yes	No	

Product Specifications

Model	ME982		ME862		ME752		
LCD Module	98"/247.8 cm diagonal		86"/217.4 cm diagonal		75"/189.3 cm diagonal		
	Pixel Pitch:	0.562 mm	0.493 mm		0.430 mm		
	Resolution:	3840 x 2160					
	Color:	Over 1073 million colors (depending on display card used)					
	Brightness*7:	450 cd/m ² (max.)					
	Contrast Ratio:	1200:1					
	Viewing Angle:	89° (typ) @ CR>10					
Frequency	Horizontal:	15 - 135 kHz (HDMI)/30 - 135 kHz (DisplayPort by USB)					
	Vertical:	23 - 76 Hz					
Pixel Clock	25 - 600 MHz (HDMI) 25 - 600 MHz (DisplayPort by USB)						
Viewable Size	2158.85 x 1214.35 mm		1895.04 x 1065.96 mm		1649.66 x 927.94 mm		
Input Signal							
DisplayPort	USB Type-C Connector	Digital RGB, YUV	DisplayPort (Up to 3840 x 2160 (60 Hz)*1, HDCP 1.3/2.2)				
HDMI	HDMI Connector	Digital RGB, YUV	HDMI (Up to 4096 x 2160 (60 Hz)*1, HDCP 1.4/2.2)				
Audio terminal							
AUDIO Input	USB Type-C	Digital Audio	PCM 32, 44.1, 48 kHz (16/20 bit)				
	HDMI Connector	Digital Audio	PCM 32, 44.1, 48 kHz (16/20 bit)				
AUDIO Output	Stereo Mini Jack	Analog Audio	Stereo L/R 0.5 Vrms				
	HDMI Connector (ARC*2)	Digital Audio	PCM 32, 44.1, 48 kHz (16/20/24 bit)				
	SPDIF terminal	Digital audio signal	For digital audio output				
Speaker Output	Internal Speaker 10 W + 10 W (Stereo)						
Control	RS-232C IN:	9 Pin D-sub					
	LAN:	RJ-45 10 BASE-T/100 BASE-TX x 2					
	Remote IN:	Stereo Mini Jack 3.5 mm Ø					
USB	USB-A	USB 2.0 Downstream port, DC 5 V/500 mA (max.) x1, USB 3.0 Downstream port, DC 5V/900 mA (max.) x 2					
	USB Type-C	For power supply, DC 5 V / 3 A (max)					
Power Requirement	4.5 - 2.1 A @ AC 100 - 240 V 50/60 Hz		4.1 - 1.9 A @ AC 100 - 240 V 50/60 Hz		3.1 - 1.4 A @ AC 100 - 240 V 50/60 Hz		
Power consumption*4 (Max/networked standby mode*5/standby mode*6/ off mode)	206.2 W (443.6 W/2.0 W/0.5 W/0.0 W)		162.2 W (404.9 W/2.0 W/0.5 W/0.0 W)		131.6 W (299.6 W/2.0 W/0.5 W/0.0 W)		
Operational Environment	Temperature*3:	0 - 40 °C / 32 - 104 °F					
	Humidity:	20 - 80 % (without condensation)					
	Altitude:	3000 m or less (Brightness may decrease with altitude)					
Storage Environment	Temperature:	-20 - 60 °C / -4 - 140 °F					
	Humidity:	10 - 90 % (without condensation) / 90 % - 3.5 % x (Temp - 40 °C) regarding over 40 °C					
Dimensions (excluding protrusions)	inch (mm)	Approx. 86.57 (W) x 2.70 (D) x 49.39 (H) (2198.9 x 68.6 x 1254.6)		Approx. 76.02 (W) x 2.68 (D) x 43.37 (H) (1930.8 x 68.0 x 1101.7)		Approx. 66.36 (W) x 2.68 (D) x 37.94 (H) (1685.6 x 68.0 x 963.7)	
Weight	lbs. (kg)	Approx. 120.2 (54.5)		Approx. 92.6 (42.0)		Approx. 75.6 (34.3)	
Tilt Angle	±15°						
Mounting interface	800 mm x 600 mm (M8, 4 Holes)						

NOTE: • Technical specifications are subject to change without notice. As a part of our policy of continuous improvement, SHARP reserves the right to make design and specification changes for product improvement without prior notice. The performance specification figures indicated are nominal values of production units. There may be some deviations from these values in individual units.

*1: Compressed image.

*2: HDMI IN1 only.

*3: When you use Option Board accessories, please contact your supplier for detailed information.

*4: Factory setting. (When no optional part is attached).

*5: When no optional part is attached. Time for power management function: 60 sec. (factory setting).

*6: When no optional part is attached. Time for power management function: 4 min. (factory setting).

*7: The Brightness level changes depending on the input settings, picture settings, installation environment, and individual product characteristics.

The overall Brightness decreases as the product ages due to deterioration over time. It does not maintain a permanent brightness level throughout the product's life.

Model	ME652	ME552	ME502	ME432
LCD Module	64.5"/163.90 cm diagonal	54.6"/138.78 cm diagonal	49.5"/125.73 cm diagonal	42.5"/107.99 cm diagonal
	Pixel Pitch:	0.372 mm	0.315 mm	0.285 mm
	Resolution:	3840 x 2160		
	Color:	Over 1073 million colors (depending on display card used)		
	Brightness*7:	450 cd/m ² (max.)		400 cd/m ² (max.)
	Contrast Ratio:	1200:1	5000:1	1200:1
	Viewing Angle:	89° (typ) @ CR>10		
Frequency	Horizontal:	15 - 135 kHz (HDMI)/30 - 135 kHz (DisplayPort by USB)		
	Vertical:	23 - 76 Hz		
Pixel Clock		25 - 600 MHz (HDMI) 25 - 600 MHz (DisplayPort by USB)		
Viewable Size	1428.48 x 803.52 mm	1209.60 x 680.40 mm	1095.84 x 616.41 mm	941.18 x 529.42 mm
Input Signal				
DisplayPort	USB Type-C Connector	Digital RGB, YUV	DisplayPort (Up to 3840 x 2160 (60 Hz)*1, HDCP 1.3/2.2)	
HDMI	HDMI Connector	Digital RGB, YUV	HDMI (Up to 4096 x 2160 (60 Hz)*1, HDCP 1.4/2.2)	
Audio terminal				
AUDIO Input	USB Type-C	Digital Audio	PCM 32, 44.1, 48 kHz (16/20 bit)	
	HDMI Connector	Digital Audio	PCM 32, 44.1, 48 kHz (16/20 bit)	
AUDIO Output	Stereo Mini Jack	Analog Audio	Stereo L/R 0.5 Vrms	
	HDMI Connector (ARC*2)	Digital Audio	PCM 32, 44.1, 48 kHz (16/20/24 bit)	
	SPDIF terminal	Digital audio signal	For digital audio output	
Speaker Output			Internal Speaker 10 W + 10 W (Stereo)	
Control	RS-232C IN:		9 Pin D-sub	
	LAN:		RJ-45 10 BASE-T/100 BASE-TX x 2	
	Remote IN:		Stereo Mini Jack 3.5 mm Ø	
USB	USB-A	USB 2.0 Downstream port, DC 5 V/500 mA (max.) x1, USB 3.0 Downstream port, DC 5V/900 mA (max.) x 2		
	USB Type-C	For power supply, DC 5 V / 3 A (max)		
Power Requirement		3.1 - 1.3 A @ AC 100 - 240 V 50/60 Hz	2.6 - 1.1 A @ AC 100 - 240 V 50/60 Hz	2.0 - 0.8 A @ AC 100 - 240 V 50/60 Hz
Power consumption*4 (Max/networked standby mode*5/standby mode*6/ off mode)		140.0 W (240.0 W/2.0 W/ 0.5 W/0.0 W)	120.0 W (220.0 W/2.0 W/ 0.5 W/0.0 W)	85.0 W (170.0 W/2.0 W/ 0.5 W/0.0 W)
Operational Environment	Temperature*3:	0 - 40 °C / 32 - 104 °F		
	Humidity:	20 - 80 % (without condensation)		
	Altitude:	3000 m or less (Brightness may decrease with altitude)		
Storage Environment	Temperature:	-20 - 60 °C / -4 - 140 °F		
	Humidity:	10 - 90 % (without condensation) / 90 % - 3.5 % x (Temp - 40 °C) regarding over 40 °C		
Dimensions (excluding protrusions)	inch (mm)	Approx. 57.61 (W) x 2.68 (D) x 33.00 (H) (1463.3 x 68.0 x 838.3)	Approx. 48.54 (W) x 2.44 (D) x 27.70 (H) (1233.0 x 62.0 x 703.5)	Approx. 44.04 (W) x 2.44 (D) x 25.17 (H) (1118.6 x 62.0 x 639.2)
Weight	lbs. (kg)	Approx. 52.7 (23.9)	Approx. 29.1 (13.2)	Approx. 25.8 (11.7)
Tilt Angle		±15°		
Mounting interface		600 mm x 400 mm (M8, 4 Holes)	400 mm x 400 mm (M6, 4 Holes)	200 mm x 200 mm (M6, 4 Holes)

NOTE: • Technical specifications are subject to change without notice. As a part of our policy of continuous improvement, SHARP reserves the right to make design and specification changes for product improvement without prior notice. The performance specification figures indicated are nominal values of production units. There may be some deviations from these values in individual units.

*1: Compressed image.

*2: HDMI IN1 only.

*3: When you use Option Board accessories, please contact your supplier for detailed information.

*4: Factory setting. (When no optional part is attached).

*5: When no optional part is attached. Time for power management function: 60 sec. (factory setting).

*6: When no optional part is attached. Time for power management function: 4 min. (factory setting).

*7: The Brightness level changes depending on the input settings, picture settings, installation environment, and individual product characteristics.

The overall Brightness decreases as the product ages due to deterioration over time. It does not maintain a permanent brightness level throughout the product's life.

Appendix-A External Resources

Additional specification documents and accessories, and optional software applications referenced in this product manual are listed below.

■Regional websites

Global: <https://sharp-displays.jp.sharp/global/index.html>

North America: <https://www.sharppusa.com/>

Europe, Russia, Middle East and Africa: <https://sharppdisplays.eu>

■Additional Documentation

“External Control” PDF document

This document defines the communications protocol for externally controlling and querying the monitor via either RS-232C or LAN. The protocol uses encoded binary and requires calculation of checksums, and most functionality in the monitor can be controlled using these commands. A simpler protocol is also available for less demanding applications (see below).

This document is available for download from our website in your region.

A Python programming language based SDK (Software Development Kit) is also available that encapsulates this communications protocol into a Python library for rapid development.

<https://github.com/SharpDisplaySolutions>

NaViSet Secure – Reference guide

This document describes the features of the NaViSet Secure technology available on this monitor.

This document is available for download. Please contact your dealer for more information.

■Software



Display Wall Calibrator software

This software provides advanced video wall configuration and accurate color matching by calibrating the monitors using an external color sensor. It is useful when setting up multi-monitor installations - such as a video wall - to achieve the best possible brightness and color matching between screens and configuring settings applicable to the video wall. The software, available for Microsoft Windows and macOS, is available for purchase and may require the use of a supported external color sensor. Please contact an authorized dealer or see our website in your region for purchase information and availability.



NaViSet Administrator software

This free software is an advanced and powerful network based control, monitoring and asset management system for monitors and projectors. The software is available for Microsoft Windows and macOS.

The latest version of the NaViSet Administrator software is available. Please contact your dealer for more information.



NaViSet Administrator Server Edition software

The NaViSet Administrator Server Edition version builds on the powerful features of its core software with the addition of enterprise level secure multi-user support, a web interface accessible via mobile devices, and support for the innovative NaViSet Secure network feature integrated into this model.

The NaViSet Administrator Server Edition for Windows is available as a subscription service. Please contact your dealer for more information.

Information Display Downloader

This software provides the latest applications and firmware to keep the monitor up to date. This software is available for Microsoft Windows. The Information Display Downloader can be downloaded from the following SHARP website.

<https://business.sharpusa.com/product-downloads>

<https://www.sharp.eu/download-centre>

Appendix-B Common Settings Menu List

Default values can be provided on request.

Picture

Picture	
Picture mode	Provides pre-configured picture settings suitable for various environments where this device may be used, or customize settings to viewer preference. TIP: • Changing any of the settings of the [Picture mode] in the OSD menu will change the settings for the current input only.
Native	Standard setting.
Retail	Bright, vivid colors ideal for advertising and branding.
Conferencing	Lower color temperature and optimized for natural human complexions.
Highbright	Maximum backlight brightness with higher color temperature for brighter ambient environments.
Transportation	Maximum backlight brightness with high contrast to read text under all conditions.
Custom	Customizable settings.
Backlight	Adjusts the overall image and background brightness. Press [+] or [-] to adjust. TIP: • When [On] is selected in [Ambient Light Sensing] at [Advanced], this function cannot be changed.
Backlight Dimming*1, *3	Dynamically adjusts the backlight of the LCD dependent on the input signal that is being displayed.
Video Black Level*1	Adjusts the black luminance.
Gamma*2	Select a monitor gamma correction for best picture quality. Selection depends on the desired usage.
Native	Gamma correction is handled by the LCD panel.
2.2	Typical monitor gamma for use with a computer.
2.4	Typical gamma settings for use with videos, such as DVDs and Blu-rays.
S Gamma	Special gamma for certain types of movies. Raises the light parts and lowers the dark parts of the image (S-Curve).
Dicom Sim.	DICOM GSDF curve simulated for LCD type. NOTE: • Do not use for diagnostic purposes.
Programmable	A programmable gamma curve can be loaded using optional software.
Color	
Color*1, *3	Adjusts the color saturation of the screen. Press + or – button to adjust.
Color Temperature	Adjusts the color temperature of the entire screen. A low color temperature will result in a reddish screen. A high color temperature will make the screen bluish. If a temperature needs further adjustment, the individual R/G/B/ levels of the white point can be adjusted. To adjust the R/G/B levels, set [Custom] as [Color Temperature] selection. MaxValue corresponds to the panel's native white point and the OSD shows [Native]. TIP: • When [Programmable] is selected in [Gamma], this function should be fixed to [Native]. • This function may not work depending on the application or MediaPlayer contents.
Color Control*1, *3	Adjusts the hue of the Red, Yellow, Green, Cyan, Blue, and Magenta colors individually. For example, you can change red to yellow or magenta.
Contrast	Adjusts the image brightness in relationship to the input signal. Press + or – button to adjust.

Picture

Advanced	
HDR Mode* ³ , * ⁴ HDMI input only	Allows selection of a preferred gamma correction when the monitor detects an HDR signal. TIP: • This function may not work depending on the application or MediaPlayer contents.
Sharpness* ¹ , * ³	Adjusts the crispness of the image. Press + or – button to adjust.
Adaptive Contrast* ¹ , * ³	Sets the level of adjustment for dynamic contrast. If [High] is set, the image is shown clearly but it makes brightness unstable due to the wide gap in contrast variation.
Aspect* ¹ , * ³	Sets the aspect ratio for the screen image or manually adjust the zoom level and position. TIP: • [Zoom] is not available for an image with an input resolution of 4K.
Normal	Shows the aspect ratio as it is sent from the source.
Full	Fills the entire screen.
Wide	Expands a 16:9 letterbox signal to fill the entire screen.
1:1	Shows the image in a 1 by 1 Pixel format. (If the input resolution is higher than the recommended resolution, the image will be scaled down to fit the screen).
Zoom	Expands/reduces the image. TIP: • The areas of the expanded image that are outside of the active screen area are not shown. The reduced image may have some image degradation.
Zoom	Maintains the aspect ratio while zooming.
Ambient Light Sensing	<p>The backlight of the LCD panel can be set to increase or decrease depending on the amount of ambient light within the room. If the room is bright, the monitor becomes correspondingly bright.</p> <p>If the room is dim, then the monitor will dim accordingly. The purpose of this function is to make the viewing experience more comfortable to the eye in a variety of lighting conditions.</p> <p>The ambient parameter setting: [Ambient Light Sensing] in OSD, select [On] and set [Illuminance] and [Backlight].</p> <p>In Bright: Setting to use in a bright room. Illuminance... The illuminance level in a bright room. Backlight The maximum level of backlight in a bright room.</p> <p>In Dark: Setting to use in a dim room. Illuminance... The illuminance level in a dim room. Backlight The minimum level of backlight in a dim room.</p> <p>Human Sensing: Shows the current setting level of [Illuminance] and [Backlight].</p> <p>When the [Ambient Light Sensing] is enabled the Backlight level of the screen changes automatically according to the lighting conditions of the room (see figure below).</p> <p>L - Illuminance level set for the monitor to use when ambient lighting is low. H - Illuminance level set for the monitor to use when ambient lighting is high.</p> <p>TIP: • When setting to [On], [Backlight] cannot be changed. • Do not cover the optional sensor unit when [Ambient Light Sensing] is enabled. [Ambient Light Sensing] is enabled when it is set to [On].</p>
Reset	Resets all picture menu settings back to factory settings except for [Picture mode].

*1: This function is not available when [HOME] is set to the input.

*2: This function is not available when [Picture Mode] is set to something other than [Custom].

*3: This function is not available when [Color Temperature] is set to [Thru].

*4: This function is not available when the current input is [USB-C].

Audio

Audio	
Audio Mode	Provides pre-configured audio settings suitable for various environments where this device may be used, or customize settings to viewer preference. TIP: • Changing any of the settings of the [Audio Mode] in the OSD menu will change the settings for the current input only.
Native	Standard setting.
Retail	Surround sound for clarity of audio in retail stores.
Conferencing	Optimized settings for clarity of audio in conference rooms.
Highbright	Lowest volume level in order to focus on the visual message (audio is mute).
Transportation	Lowest volume level in order to avoid disturbance in public spaces (audio is mute).
Custom	Customizable settings.
Volume	Increase or decrease the sound output level.
Balance	Independent audio channels for routing the audio signal. Press the – or + button to adjust the sound balance between the left and right speakers.
Treble	Accentuates or reduces the high frequency range of audio signals. Press the + button to increase [Treble]. Press the – button to decrease [Treble].
Bass	Accentuates or reduces the low frequency range of audio signals. Press the + button to increase [Bass]. Press the – button to decrease [Bass].
Reset	Resets all audio menu settings back to factory settings except for [Audio Mode].

Appendix-c Administrator Settings Menu List

Input & Output

Input & Output	
Input Change	
Startup App	Sets which application to automatically start.
Auto Input Change	When enabled, this option can detect and change inputs when a signal is applied or lost. Allows for customization of the input priority. TIP: • This option is unavailable when these OSD menu options are enabled: [Human Sensing] is enabled in the [Setup] menu.
None	The monitor does not search for video signal on the other input connections. If video signal is lost on the current input, or if the monitor is manually switched to an input that does not have video signal, the screen will go black and the LED will flash green. If [Power Save] is enabled, the monitor will enter power saving mode after the period of time set for [Power Save] has passed.
First Detect	The monitor does not search for a video signal on the other input connections while the current input has a video signal. If the current input connection does not have video signal present, the monitor will search for video signal on the other video input connections. If a video signal is found, the monitor will switch from the current input to the input with the active video source automatically.
Last Detect	The monitor actively searches for a video signal on the other input connections, even while the current video signal is present. When a new video signal source is applied to another input connection, the monitor automatically switches to the newly found video source. If the video signal is lost on the current input connection, the monitor will search for video signal on the other video input connections. If a video signal is found, the monitor will switch from the current input to the input with the active video source automatically.
Custom Detect	The monitor only searches for video signal on the inputs selected for the priority numbers. If the signal is lost, the monitor searches for signal in the priority order and automatically switches to the highest priority input it finds with an active video signal. The monitor actively searches these inputs. If the current signal input is not Priority 1 and a new signal is applied to the input assigned to Priority 1, the monitor will automatically switch to the higher priority input.
Custom: Priority 1 Custom: Priority 2 Custom: Priority 3	
Input Name Setting	Allows for setting a custom name for the input mode for each input terminal. Check [Input Alias Switch] and select the input to change the name.
Input Select Setting	Sets the inputs available in the Input Change menu. On: The input is available in the input list. Off: The input is not available in the input list. Auto: Show the input name only when the cable is connected.

Input & Output	
Signal Setting	
HDMI Mode	Selects the type of HDMI mode (version) [Mode1] or [Mode2]. Mode1: Max resolution is 3840 x 2160 (30 Hz). Mode2: Max resolution is 3840 x 2160 (60 Hz), HDCP 2.2, or HDR.
USB-C Setting	Auto: Recommended setting. Generally used with most commercially available USB Type-C cables. USB2.0: Sets the compatibility to USB 2.0 to improve detection and communication. TIP: • If the operation is unstable, try a different manufacturer's USB Type-C cable instead of using the USB 2.0 setting.
Video Range	Adjust the gradation range to be shown according to the video signal to improve the whiteout and blackout of the image. TIP: • This function is available only when [HDMI] or [USB-C] is the selected input signal. Auto: Automatically sets input signals by adjusting connected equipment. Expanded Signal: For audio-visual equipment settings. Expands the input signals from 16-235 gray levels to 0-255 gray levels. Raw Signal: For computer settings. Show all input signals of 0-255 gray levels.
Sound Setting	
Line Out	Sets the volume of sound output from the audio output terminal. The volume from the digital audio output (optical) terminal is fixed regardless of the setting.
Fixed	Fixes the volume from the audio output terminal. Adjust the volume by using an external device.
Variable	You can adjust the volume from the speakers of this monitor and the audio output terminal simultaneously by using "Volume".
Internal Speaker	Enables or disables sound output from the internal speakers.
Audio Delay	Select this option if there is a noticeable delay between the video image and the audio signal output.
Audio Delay	When this option is on, the audio signal can be delayed between 0 to 100 milliseconds. This allows delays in the video, that may occur due to video processing such as DEINTERLACE, to be matched by an equal delay in the audio signal to avoid lip-sync errors.
Delay Time	
CEC	
CEC	Allows control cooperation when CEC devices are connected via HDMI to the monitor. When CEC is ON, the monitor switches automatically to the input of the CEC device. If you turn off CEC on the CEC device, the monitor will not switch automatically. The monitor's wireless remote control can be used to control some of the media player device functions. When [CEC] is enabled, the wireless remote control CEC functions are: 1 (⏪), 2 (▶), 3 (⏩), 5 (■), 6 (⏪), ENT, EXIT, ▲, ▼, ◀, ▶, MUTE, VOL+, VOL-. Depending on the type of the connected device, the CEC functions may not work as described. Not all manufacturers provide the same level of CEC integration and control, or they may only provide support for their products. TIP: • When [On] is selected, the monitor will quickly return to the ON state from standby state. Enabling this option increases standby power consumption.
Auto Turn Off	The HDMI-CEC compatible device goes into standby at the same time as the monitor when the STANDBY button is pressed on the remote control, or when the  button is pressed on the monitor. TIP: • The connected HDMI-CEC compatible device may not go into standby if it is recording.
Audio Receiver	When [Enable] is selected, the internal speaker is muted and connected audio equipment with ARC function outputs the sound. When [Disable] is selected, connected audio equipment with ARC function is muted and the internal speaker outputs the sound. TIP: • It may take a while to output the sound when changing [Audio Receiver] settings; this is not a failure in the monitor.
Reset	Resets all input menu settings back to factory settings except for [Custom: Priority] and [Input Name Setting].

Schedule

Schedule	
Power On Schedule	Turns the monitor power on at the specified time. See page 38 .
Add Power On Schedule	Settings for configuring the power on schedule for the monitor.
Power Off Schedule	Turns the monitor power off at the specified time.
Add Power Off Schedule	Settings for configuring the power off schedule for the monitor.
Reboot Schedule	Restarts the Android system at the specified time.
Add Reboot Schedule	Settings for configuring when to reboot the Android system.
Schedule List	Shows a list of schedules configured for the monitor. Schedules can be enabled, disabled, edited, or deleted from the list.
Reset	Resets all schedule menu settings back to factory setting.

- TIP:
- The [Date & Time] needs to be set before adding schedules.
 - Each schedule must be set at an interval of 5 minutes or more.
 - Up to 15 different schedules can be created.
 - When using the schedule function to turn off, turn on, or reboot, the input set in [Input Change] will take priority and be shown. If the same image does not show before activating the schedule function, please set the input signal again.

Network

Network	
Ethernet	
Ethernet	Sets whether or not to use a LAN terminal. Configures the IP address and network information automatically or manually.
Obtain IP Address Automatically	Sets whether or not to obtain the IP address automatically from the DHCP server. When manually setting the IP address and other network settings, contact the network administrator for the required information.
IP Address	Enter the IP address for the monitor to use on the connected network when not using [Obtain IP Address Automatically].
Default Gateway	Enter the gateway for the network when not using [Obtain IP Address Automatically].
Netmask	Enter the subnet mask data for the network when not using [Obtain IP Address Automatically].
DNS 1	Enter the primary DNS server settings for the network when not using [Obtain IP Address Automatically].
DNS 2	Enter the secondary DNS server settings for the network when not using [Obtain IP Address Automatically].
MAC Address	Shows the monitor's [MAC Address].
Proxy	Sets the proxy server settings of the network connected to the monitor. None: No set the proxy. Manual: Set the host name, port number, and address. Proxy Auto-Config: Set the URL that the proxy PAC file is on.
Ping	
IP Address	Sets an [IP Address] for sending [Ping].
Execute	Checks a reply can be sent to the monitor or not from the [IP Address] by sending [Ping].

Network	
Network Settings	
HTTP Server	Sets whether or not to use HTTP server functions.
PJLink	Enables the use of the [PJLink] (see page 49).
AMX	To turn on or off for the detection from AMX Device Discovery when connecting to a network supported by an AMX's NetLinX control system.
Monitor Control via Network	Sets whether or not to control this monitor via the network. When disabled, these functions do not work: External Control, HTTP server, SNMP, Crestron, AMX, PJLink.
NaViSet Secure	Enables the use of the monitor's NaViSet Secure function. When disabled, the monitor cannot be remotely managed over a network via the NaViSet Secure encrypted communications tunnel, and the NaViSet Secure settings are not available in the OSD menu.
Crestron	Enables the use of the [Crestron Connected] function. When disabled, the Crestron function are not available in the OSD menu.
Host Name	Type in the hostname of the network to the monitor. Up to 15 alphanumeric characters can be used.
Monitor Control	
User Name	Sets an account name when connecting to this monitor.
Password	Sets a password when connecting to this monitor. Press [OK] to proceed and create a new password.
Port	Sets the port number to be used.
Auto Logout Time(minutes)	Sets the time to logout automatically by minutes when there is no communication.
Use Secure Protocol for Authentication	Enable to use a secure protocol for authentication when connecting to this monitor. When enabled, it sets the public key file.
Public Key File	This monitor supports the following public keys. RSA (2048bit or more), DSA, ECDSA-256, ECDSA-384, ECDSA-521, ED25519. Upload: Upload the public key file to this monitor. Download: Export the public key file uploaded to this monitor. Delete: Delete the public key file uploaded to this monitor.
Reset	Initialize the telnet server settings.
NaViSet Secure	
Provides an encrypted peer-to-peer secure connection for remote management and control of the monitor via LAN or Internet. TIP: This menu includes the monitor's IP address, model name, and serial number.	
NaViSet Secure Remote	Provides secure remote access to the display for management via the Internet. When disabled, only secure local access via LAN is available. You will be prompted to accept a usage agreement when enabling this feature. The specified device-identifying information in this menu is sent to a secure remote registration server, which is required for remote access. TIP: <ul style="list-style-type: none"> This setting requires an active Internet connection. The "Remote Status" indicates the status of the monitor's connection to the Internet-based cloud server after enabling [NaViSet Secure Remote] and accepting its usage agreement. This status does not apply to LAN connection communication.
Pairing Mode	Sets the type of connection to use with the monitor. <ul style="list-style-type: none"> [Local]: Pairs with an application running on the same network as the monitor. No Internet connection is required. [Remote]: Pairs with an application running on a different network than the monitor via the Internet. An Internet connection is required.
Use Pairing Code	When enabled, it requires a code when pairing the monitor with an application. When [Pairing Mode] is [Local], this function is optional and can be disabled. It allows for a quick, less secure connection to the monitor while open for local pairing. TIP: A code is always required when the [Pairing Mode] is [Remote].
Start Pairing	This opens the monitor for pairing. The monitor remains open to pairing for 72 hours. If not successfully paired within that time, the pairing mode will automatically close.

Network	
IP Address Filter	Sets the IP address that prohibits connection to this monitor.
Crestron Connected	<p>This monitor can be controlled via network using equipment and application software of Crestron Electronics, Inc.</p> <p>This is a function to connect a system developed by Crestron Electronics, Inc. which manages and controls multiple system devices connected to the network.</p> <p>For details, refer to the Crestron Electronics, Inc. website. https://www.crestron.com/</p> <p>This monitor supports “Crestron Fusion” and “Crestron XiO Cloud”, and is compatible with the Crestron XiO Cloud service.</p> <p>For details, refer to the Crestron Electronics, Inc. website. https://www.crestron.com/Products/Featured-Solutions/Crestron-Fusion https://www.crestron.com/Products/Featured-Solutions/XiO-Cloud</p>
Control System	
Control System*1	<p>Sets whether or not to use Control System.</p> <p>Set to on this function after the setting is completed.</p>
IP Address	Sets the IP address for Control System.
Port	Sets the port number to connect to Control System.
IP ID	Sets the IP ID for Control System.
Virtual Control Room ID	<p>Sets the ID for Virtual Control Room.</p> <p>When do not use Virtual Control Room, set to blank this item.</p>
Use TLS	Sets whether or not to use encrypted communication by TLS.
User Name	Sets the username when using TLS.
Password	Sets the password when using TLS.
Verify Certificate	Sets whether or not to authenticate with a certificate when using TLS.
Manage Certificate	Add the certificate of Control System to this monitor.
Fusion On-Premises	
Fusion On-Premises*1	<p>Sets whether or not to use Fusion On-Premises.</p> <p>Set to on this function after the setting is completed.</p>
Port	Sets the port number to connect to Fusion On-Premises.
IP ID	Sets the IP ID for Fusion On-Premises.
Fusion in the Cloud	
Fusion in the Cloud*1	<p>Sets whether or not to use Fusion in the Cloud.</p> <p>Set to on this function after the setting is completed.</p>
Fusion Cloud URL	Sets the URL of Fusion in the Cloud.
Port	Sets the port number to connect to Fusion in the Cloud.
Verify Certificate	Sets whether or not to authenticate with a certificate when connecting to Fusion in the Cloud.
Manage Certificate	Add the certificate of Fusion in the Cloud to this monitor.
XiO Cloud	
XiO Cloud	<p>Sets whether or not to use XiO Cloud.</p> <p>Set to on this function after the setting is completed.</p>
Cloud URL	Sets the URL of XiO Cloud.
Host Name	Displays the host name when connecting to XiO Cloud.
Serial Number	Displays the serial number when connecting to XiO Cloud.
Model Name	Displays the model name when connecting to XiO Cloud.
Mac Address	Displays the MAC address when connecting to XiO Cloud.
Auto Discovery	Sets whether or not to automatically detect this monitor.
Reset	Initialize the “Crestron Connected” settings.
Reset	Resets all network menu settings back to factory setting, except for following items: [Ping], [NaViSet Secure] and [Crestron] under [Network Settings], [Monitor Control], [NaViSet Secure].

*1: Cannot be used simultaneously. Only one of [Control System], [Fusion On-Premises] and [Fusion in the Cloud] can be set to on.

Protect

Protect	
Power Save Settings	
Power Save	<p>Enables or disables the monitor's ability to enter power saving mode.</p> <p>When enabled, the monitor goes into power saving mode after the period of time has passed with no input signal detected or signal loss has occurred.</p> <p>Set the power saving condition in [Mode].</p> <p>When the monitor is in power saving mode, the LED power indicator will change color. Refer to the Power indicator table (see page 20).</p> <p>The monitor will enter the state selected for [Mode] in the following condition:</p> <ul style="list-style-type: none"> • The monitor is powered off by pressing the main power switch. • The monitor is powered off by pressing the POWER ON button on the remote control. • The monitor is powered off by [Power Off Schedule] in [Schedule]. • The monitor is powered off by an external control. <p>Please refer to the monitor's specifications (see page 55) for power consumption information.</p> <p>When disabled, the monitor doesn't go into power saving mode.</p> <p>TIP: • When the monitor is connected to a computer, the computer's display adapter may not stop sending digital data even though there is no image on-screen. If this occurs the monitor will not switch into standby state.</p> <ul style="list-style-type: none"> • The [Power Save] function is disabled when [Human Sensing]*1 is enabled in the [Setup] menu. <p>*1: The function is available only when connecting the optional sensor unit.</p>
Time Settings	Sets the amount of time the monitor should wait for input signal before going into power save state.
Mode	<p>When [Low Power] is selected, the monitor cannot detect an input signal from the connected device and will not turn on automatically. To turn on the monitor, press the main power switch on the monitor or the POWER ON button on the remote control, or disconnect and reconnect the device's signal cable.</p> <p>When [Normal] is selected, the monitor turns on by detecting an input signal from a connected device. Set to [Normal] when using an external control function (see page 45).</p>
USB Power	<p>Controls power delivery to the USB Type-C port when the monitor is in standby state.</p> <p>On: Always supply power, even when the monitor is in standby state.</p> <p>Auto: Supply power to the port only when connecting a device to the port.</p> <p>Off: No power is supplied to the port.</p> <p>TIP: • Power consumption by a device connected to this port depends on the USB device.</p>
Power Save Message	Shows a message as the monitor is entering low power mode.
Quick Start	When [On] is selected, the monitor will quickly return to the ON state and display an image when a signal is detected or when returning from standby state. Enabling this option increases standby power consumption.
Off if No Operation Home Screen	<p>Determines whether or not to turn the monitor off when there is no operation from the remote control, RS-232C commands, or LAN commands.</p> <p>When setting the time options on [Home Screen], the monitor will turn off at the specified time.</p>
Security Settings	Requires a password to be entered to use the monitor.
Password	Input the current password to change the settings in this menu.
Lock Admin Setting	Sets whether or not a password is necessary when using Administrator Settings and Updater.
Start-Up Lock	The password is required when powering on the monitor.
Control Lock	The password is required when pressing a button on the display's button panel or remote control.
Lock Settings	<p>Prevents the monitor from being controlled by the wireless remote control, the buttons on the monitor, or both.</p> <p>When [Activate] is selected, all settings are activated.</p> <p>TIP: • [IR] is a function intended only for the wireless remote control buttons. This function does not lock out access to the buttons on the monitor.</p> <ul style="list-style-type: none"> • To return to normal operation, press the DISPLAY button on the remote control and hold it down for more than 5 seconds.
Select	Selects the device, [IR], [Key] or [Key & IR].
Mode	Selects the mode [Unlock], [All Lock] or [Custom Lock].
Unlock	All buttons are available for normal operation.

Protect	
All Lock	Locks all buttons.
Custom Lock	All buttons are locked except for those that can be individually unlocked for custom settings. See page 41 and page 42 .
Advanced	
User Apps Installation	Sets whether or not to allow installation of apk application files. NOTE: <ul style="list-style-type: none"> • 3rd party applications of this type are not guaranteed to work and are outside the scope of support and warranty. • Always verify the authenticity and safety of an application before installation. Some applications may affect the operation of other applications and of this monitor. Virus infections or, data corruption, falsification, or theft is possible.
Application Lock	Sets whether or not to lock the use of the following applications. Enables or disables the availability of some of the monitor's pre-installed applications. When enabled, all the following applications are locked and cannot be used: <ul style="list-style-type: none"> • Updater • Web Browser • EShareServer
Enable USB Drive	Sets whether or not to allow the use of a USB flash drive.
Delay Time	Delays the monitor from turning on for the amount of time set when the POWER ON button is pressed. The delay can be set between 0 and 50 seconds.
Reset	Resets all security menu settings back to factory setting, except for [Delay Time] and [Security Settings].

Setup

Setup	
App Icon Layout	Sets the icons of the applications to be arranged on the home screen.
PIP	TIP: <ul style="list-style-type: none"> • This function is released when turning off the main power switch.
PIP Enable	Displays a sub-screen inside a main screen. TIP: <ul style="list-style-type: none"> • PIP is only available for use in the Android source for its main screen. • This function is available only when [Screen Rotation] is set to [Landscape].
PIP Source	Selects the input signal of the sub-screen: [HDMI1]/[HDMI2]/[HDMI3]/[USB-C].
PIP Position	Selects the position of the sub-screen: [Top-Left]/[Top-Right]/[Bottom-Left]/[Bottom-Right].
PIP Size	Selects the size of the sub-screen: [Small]/[Medium]/[Large].
Tile Matrix	TIP: <ul style="list-style-type: none"> • This function is not available when the HOME screen is shown.
Tile Matrix	Allows one image to be expanded and shown over multiple screens (up to 25) through a distribution amplifier.
H Monitors	Number of monitors arranged horizontally.
V Monitors	Number of monitors arranged vertically.
Position	Sets the section of the tiled image to view on the current monitor.
Tile Comp	Adjusts the image to compensate for the gap between monitors.
Human Sensing*1	Automatically adjusts the backlight and volume levels based on whether or not a human presence is detected in front of the monitor. TIP: <ul style="list-style-type: none"> • Human sensing is automatically disabled if [Auto Input Change] is set while [Human Sensing] is active. • [Power Save] is disabled when [Auto Off] or [Custom] is selected in [Human Sensing].
Human Sensing	
Auto Off	The monitor's backlight automatically turns off, and the volume mutes when no human presence is detected during the period set at [Waiting Time]. When a person is near the monitor again, the monitor will automatically return to normal mode.
Disable	Human sensing function is off.
Custom	The monitor's input signal, backlight and volume levels automatically shift to the setting at [Input Select], [BackLight] and [Volume] when no human presence is detected during the period set at [Waiting Time]. When a person is near the monitor again, the monitor will automatically return the backlight and volume to normal levels and reproduce the input signal selected for [Input Select].

Setup	
Clone Setting	Allows for exporting and importing some of the OSD menu settings between monitors. The settings are saved on a USB storage device (formatted FAT16 or FAT32) connected to the monitor's USB port. USB Read: Imports the monitor settings from a connected USB flash drive. USB Write: Exports the monitor settings to a connected USB flash drive. TIP: <ul style="list-style-type: none"> The settings are imported for all input terminals. This function is available only between models with the same name and same firmware version.
Picture	Individually select each OSD menu function's settings to import. TIP: <ul style="list-style-type: none"> The selection of which settings to copy is reset to default if the monitor's main power is turned off.
Audio	
Input & Output	
Schedule	
Network	
Protect	
Setup	
System	
Copy Start	Initiates import or export of the OSD menu settings.
Advanced	
Power Indicator	Turns on or off the LED that indicates the monitor is powered on and in active mode. The monitor's power LED will not glow when this setting is [unable].
Mute Setting	Allows you to mute the monitor's audio and video output. NOTE: <ul style="list-style-type: none"> This function does not work on the application or Home Screen. TIP: <ul style="list-style-type: none"> The Mute Setting is released in the following cases: <ul style="list-style-type: none"> Changing the input signal. Turning off/on the main power switch, or with the  button on the remote control or main unit. Returning the unit from power save. Changing the [Mute Setting], [Audio Mode], or when the volume is changed with the remote control or main unit key. Changing the video signal (resolution/scanning frequency). [Video] and [Audio & Video] may not work depending on the application or MediaPlayer contents.
Audio	Mutes the audio output when the remote control's MUTE button is pressed.
Video	Mutes the video output when the remote control's MUTE button is pressed.
Audio & Video	Mutes the audio and video output when the remote control's MUTE button is pressed.
Command Format	Select the command format. For details of each command, see the manual on the following website. https://sharp-displays.jp.sharp/global/index.html
Control Terminal	Selects control terminal in standby state, [RS-232C] or [Lan].
Monitor ID	Sets the monitor's ID number between 1 and 25. This number is also used by the remote control when in ID mode. TIP: <ul style="list-style-type: none"> It is strongly recommended so that the monitor can be individually identified and controlled.
Reset	Resets all setup menu settings back to factory setting, except for [App Icon Layout].

*1: The function is available only when connecting the optional sensor unit.

Application

Application	
	Manages the installed applications.

System

System	
Date & Time	TIP: • When a period of about two weeks has passed after disconnecting the power cord of the monitor, the time will be initialized and the clock function will stop. If the clock function has stopped, configure the [Date & Time] again.
Date & Time	
Use 24-Hour Format	Sets whether or not to display the time in the 24-hour format.
Automatic Date & Time	Sets whether or not to set the data & time automatically via network.
Set date	Sets the date. Shown when [Automatic Date & Time] is set to off.
Set time	Sets the time. Shown when [Automatic Date & Time] is set to off.
Date format	Sets the display format for the date.
Time Zone	Sets the time zone.
Language & Keyboard	
Language	Sets the display language for the screen.
Virtual Keyboard	Selects the keyboard to display on the screen.
Physical Keyboard	Shows information about the physical keyboard used. Sets whether or not to display a keyboard on the screen when a physical keyboard is connected.
OSD	
OSD Time	Turns off the OSD after a period of inactivity. The preset choices are 10-240 seconds.
Information OSD	Selects whether or not to automatically show information about the monitor when it powers on, changes input, or the current input signal changes. The information includes the current input, audio source, aspect ratio, resolution, and refresh rate. The monitor's ID and IP address are also shown unless their setting is OFF. Note that the information OSD is also displayed when pressing the DISPLAY button on the remote control. The remote control function cannot be turned off.
Communication Information	Selects whether or not to show the [IP Address] when the [Information OSD] is [On]. The information is set in [Ethernet] at [Network].
Screen Rotation	Changes the OSD menu and image orientation. The OSD menu and image rotate direction are synchronized and will show in the same orientation. TIP: • The HDMI/USB-C terminal does not support automatically rotating images to a portrait orientation. Only the OSD menu rotates when [Portrait] is set. • When you change the [Screen rotation] setting, the home screen appears momentarily and then automatically return to the input signal you set.
Landscape	Shows the image in landscape orientation.
Portrait	Shows the image in portrait orientation.
180°Rotate	Shows the image in upside down.
Logo Screen	Sets whether or not to display the logo screen when turning the power on.
Startup Animation	Sets whether or not to display the animation when turning the power on.
Wallpaper	Sets the background of the home screen.
Storage Space	Displays the capacity of the internal storage of this monitor and the external storage connected to this monitor.
Update Firmware	Confirms the firmware version and updates the firmware. TIP: • After updating the firmware to the latest version, it cannot be restored to a previous version.
Current Version	Displays the current firmware version.
Update	Updates the monitor firmware from a connected USB drive containing a firmware file. Press "Check" to initiate the update. TIP: • Any applicable firmware versions for your monitor are available for download from our websites (see page 57). The firmware download file set includes instructions for updating the firmware via USB. When updating the FW via USB, connect the USB drive to the USB1 or USB2 port on the monitor (see page 16).

System	
Security	
Trusted Credentials	Displays the trusted credentials.
User Credentials	Displays the user credentials.
Install From Storage	Installs a file from the connected storage.
Clear credentials	Deletes all credentials.
Reset	Resets all system menu settings back to factory setting, except for [Date & Time], [Language & Keyboard] and following items in [OSD]: [Screen Rotation], [Logo Screen], [Startup Animation], [Wallpaper].
Factory Reset	All items are returned to factory shipment state.

About

About	
Monitor Information	Shows the model name, serial number and firmware version of the monitor. [Carbon Savings]: Shows the estimated carbon saving information in kg-CO ₂ . The carbon footprint factor in the carbon saving calculation is based on the OECD (2008 Edition). [Carbon Usage]: Shows the estimated carbon usage information in kg-CO ₂ . This is the arithmetic estimation, not actual measurement value. This estimation is based without any options.
Legal Information	

Mounting Precautions (For SHARP dealers and service engineers)

Please read [“Important Information”](#) carefully before installation.

Mounting the monitor requires expertise and the work must be carefully performed by a trained service person in accordance with the section.

Mounting (for Trained Installers)

Carefully inspect the location where the unit is to be mounted. Not all walls or ceilings are capable of supporting the weight of the unit. The weight of this monitor is provided in the specifications (see [“Product Specifications”](#) on page 55). Product warranty does not cover damage caused by improper installation, re-modeling, or natural disasters. Failure to comply with these recommendations could result in voiding the warranty.

To ensure safe installation, use two or more brackets to mount the unit. Mount the unit to at least two points on the installation location.

Allow for adequate ventilation or provide air conditioning around the monitor, so that heat can properly dissipate away from the monitor and from the mounting equipment.

Please note the following when mounting on a wall or ceiling:

- We recommend mounting interfaces that comply with UL1678 standard in North America.
- For detailed information, refer to the instructions included with the mounting equipment.

We strongly recommend using the screws as shown below.

If using screws longer than below mentioned, check the depth of the hole.

	Screw Size		Bracket Hole	No Thread	Recommended Fasten Force
	(A)	(B)	(C)	(D)	
ME982	M8 (4 pcs)	12~16 mm	≤ Ø 12 mm	1 mm	950-1600 N•cm
ME862		12~18 mm			
ME752					
ME652	M6 (4 pcs)	8~14 mm	≤ Ø 8.5 mm		390-670 N•cm
ME552					
ME502					
ME432					

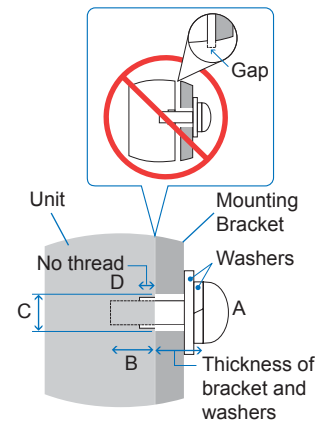

NOTE: • When used in a video wall configuration for a long time, slight expansion of the monitors may happen due to temperature changes. It is recommended that a gap of over one millimeter is kept between adjacent monitor edges.

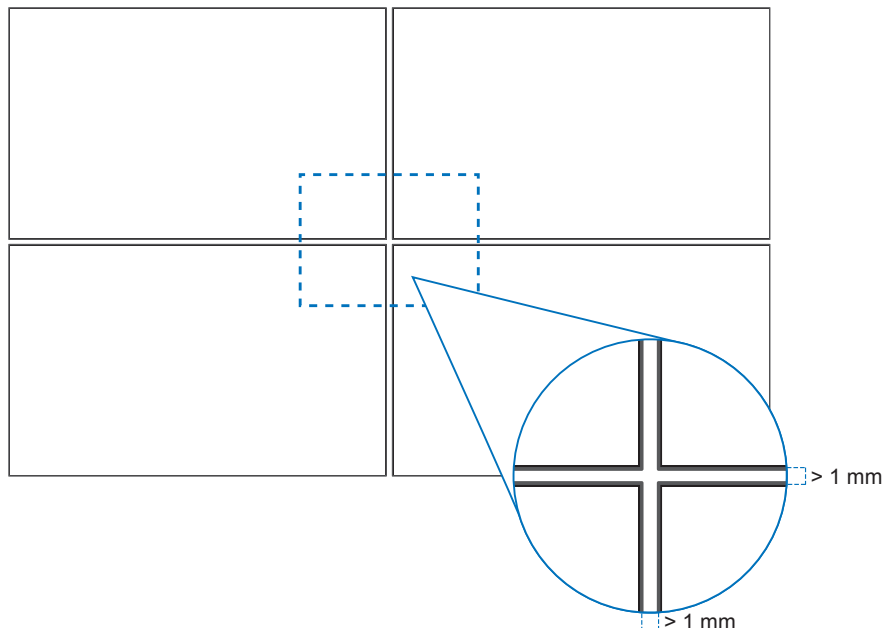

■Installing a safety wire

NOTE: • When installing, do not apply pressure to the LCD panel or excessive force to any part of the monitor by pushing or leaning on it. This may cause the monitor to become distorted or damaged.

Handles for safety wire

Attach the safety wire to the handles shown in the figure below.

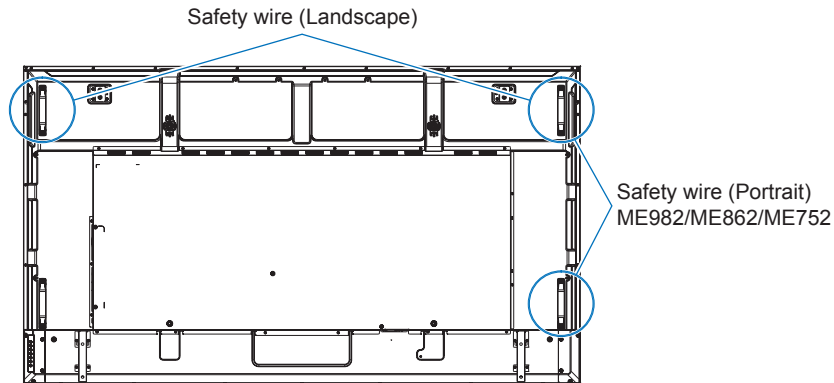

■Attaching Mounting Accessories

Be careful to avoid tipping the monitor when attaching accessories.

1. Attach eyebolts for mounting (ME982/ME862/ME752)

This model is equipped with pre-installed eyebolt brackets for attaching eyebolts (not included) to aid in mounting.

- Screw the eyebolts into eyebolt holes in eyebolt brackets as shown in the picture.
- Be sure the eyebolts are secure.
- Do not mount the monitor using only the eyebolts. Eyebolts are for temporary use only.
- This monitor is designed to be installed on a concrete wall or pillar. Reinforced work might be necessary for some materials such as plaster / thin plastic board / wood before starting installation. This monitor and bracket must be installed on a wall which can endure at least 4 times or more the weight of the monitor. Install by the most suitable method for the material and the structure.

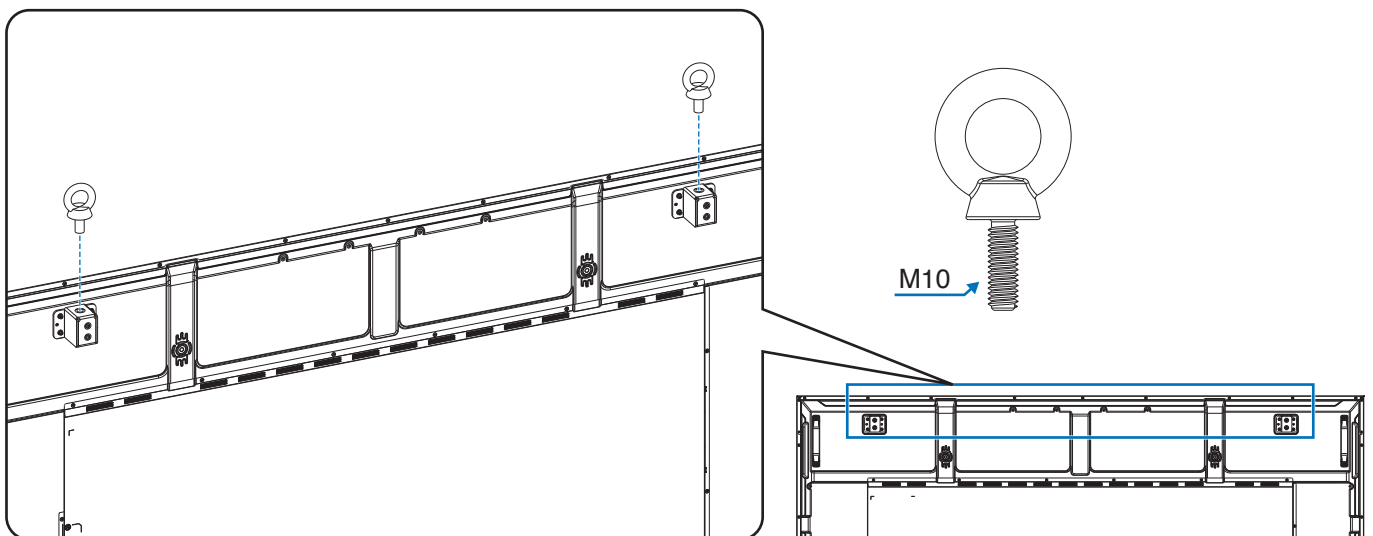

2. Attach Mounting Accessories

Be careful to avoid tipping the monitor when attaching accessories.

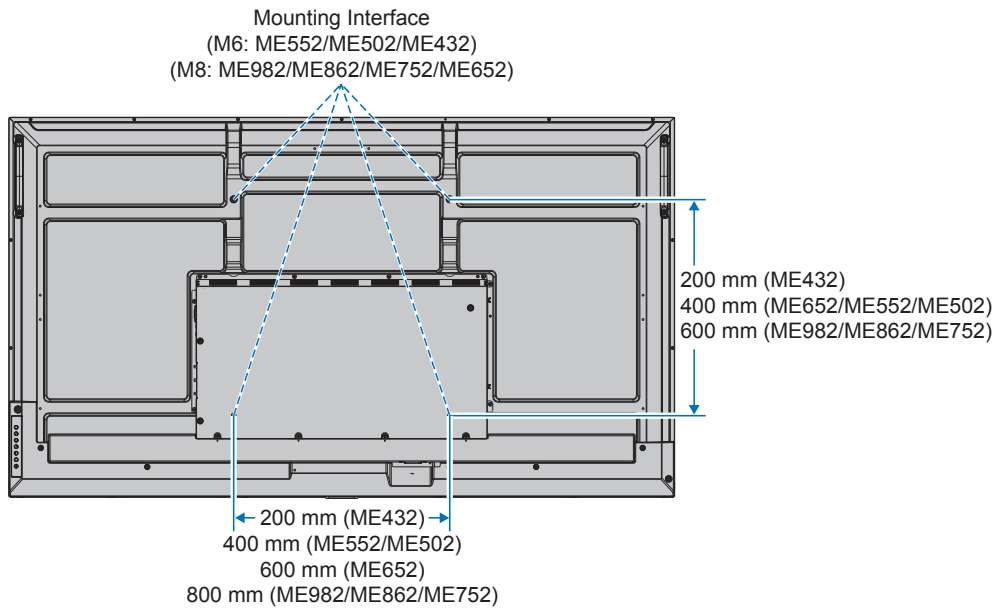

Mounting accessories can be attached with the monitor in the face down position. To avoid scratching the LCD panel, always place a soft cloth, such as a blanket that is larger than the monitor's screen area, on the table before laying the monitor face down. Make sure there is nothing on the table that can damage the monitor.

- NOTE:**
- Prior to installation, place the monitor face down on a flat even surface that is larger than the monitor screen. Use a sturdy table that can easily support the weight of the monitor.
 - To avoid scratching the LCD panel, always place a soft cloth, such as a blanket that is larger than the monitor's screen area, on the table before laying the monitor face down when installing the monitor stand or mounting accessories.

■Orientation

- When using this monitor in a portrait position (viewing from the front), ensure to rotate it clockwise so that the left side is moved to the top and the right side is moved to the bottom.
- If installed in the wrong orientation, heat may be trapped inside the main unit and the lifetime of the monitor may be shortened.
- It cannot be installed upside down.

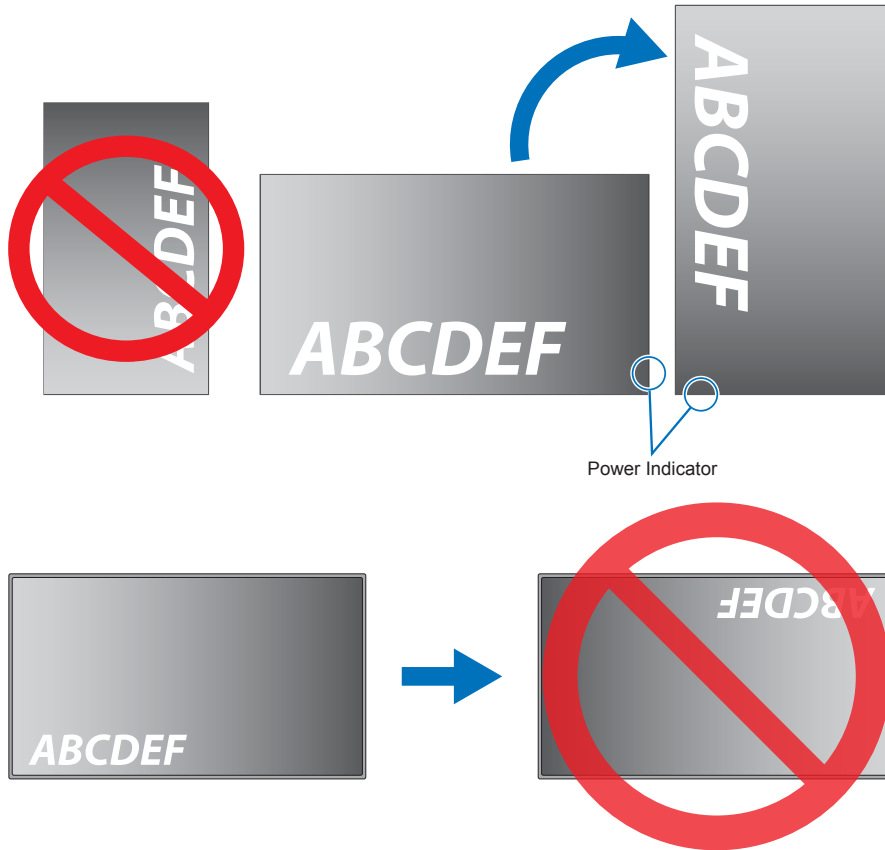

The monitor cannot tilt 16° or more.

NOTE: • Installing the monitor at an angle of 16° or more may cause a malfunction.

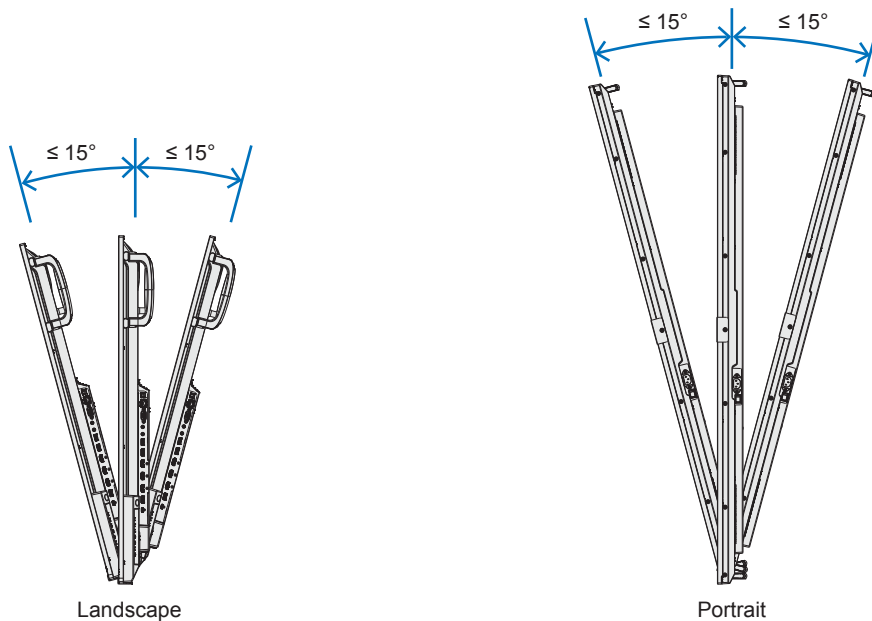

■ Ventilation Requirements

When mounting in an enclosed space or recessed area, leave adequate room between the monitor and the enclosure to allow heat to disperse, as shown below.

- NOTE:**
- Allow adequate ventilation or provide air conditioning around the monitor, so that heat can properly dissipate away from the unit and the mounting equipment; especially when you use monitors in a multiple screen configuration.
 - If the monitor overheats, a “Caution” warning appears. If the “Caution” warning appears, stop using the unit, turn off the power and allow it to cool.

For the monitor in landscape orientation

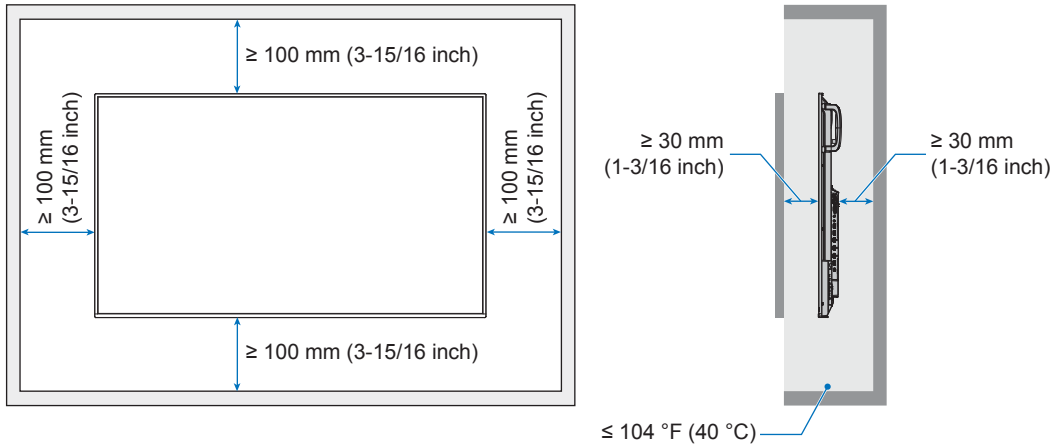

For the monitor in portrait orientation

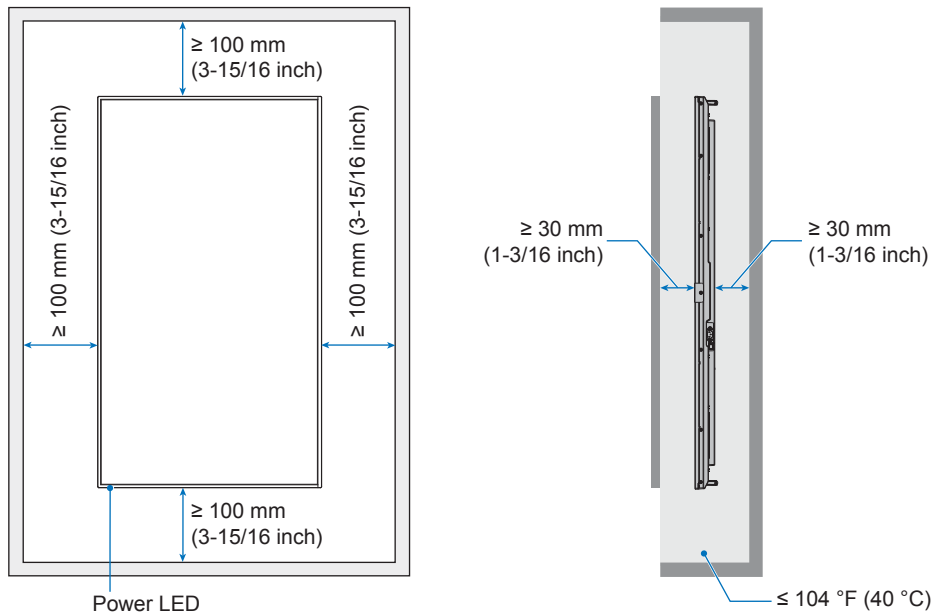

Manufacturer's Recycling and Energy Information

We are strongly committed to environmental protection and sees recycling as one of the company's top priorities in trying to minimize the burden placed on the environment. We are engaged in developing environmentally friendly products, and always strive to help define and comply with the latest independent standards from agencies such as ISO (International Organization for Standardization) and TCO (Swedish Trades Union).

Energy Saving

This monitor features an advanced energy saving capability. When a Display Power Management signal is sent to the monitor, the Energy Saving mode is activated. The monitor enters a single Energy Saving mode.

For additional information visit:

<https://www.sharpusa.com/> (in USA)

<https://sharpdisplays.eu> (in Europe)

<https://sharp-displays.jp.sharp/global/index.html> (Global)

Addition explanation to EcoDesign Regulation

The following setting conforms to the "Normal Configuration" as defined in the "EcoDesign Regulation ((EU) 2019/2021)" and is the recommended setting.

- [Power Save] is enabled
- [Mode] is set to [Low Power]
- [USB-Power] is set to [Auto]
- [Power Save Message] is enabled
- [Quick Start] is set to [Off]
- [Human Sensing] is set to [Disable]

If you change some of these setting the power consumption can be higher than using the recommended setting.

Due to the various possibilities to save energy, the different power modes named as "standby state".

"Standby state" mean "standby mode" or "networked standby mode" if the recommended setting are used.

The monitor enter into "standby mode" if you use the recommended setting and haven't connected a LAN network. Using the recommended setting and a active LAN connection "standby state" means "networked standby mode".

SHARP
SHARP CORPORATION